

Tecnico — 2019  
*Tavolo, Terra,  
Sospensione, Soffitto,  
Parete, Esterno.*

**FOSCARINI**

Tecnico — 2019

Europe

Valid from 1<sup>st</sup> January 2019

**FOSCARINI**



## Index

## Tavolo →



Anisha  
→ p. 014



Behive  
→ p. 015



Binic  
→ p. 018



Birdie  
+ Birdie LED  
→ p. 016-017



Buds 1 - 2 - 3  
→ p. 019



Caboche  
→ p. 020



Filo  
→ p. 021



Gem  
→ p. 022



Gregg  
→ p. 023



Kurage  
→ p. 028



Lumiere  
+ Lumiere 25<sup>th</sup>  
→ p. 024-026



Lumiere XXL + XXS  
→ p. 027



Magneto  
→ p. 029



Plass media  
→ p. 030



Poly Gregg  
→ p. 031

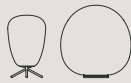

Rituals + XL  
→ p. 032-033



Satellight  
→ p. 034



Soffio  
→ p. 035



Twiggy XL  
→ p. 036



Uto  
→ p. 037

## Terra →



Birdie  
+ Birdie LED  
→ p. 040-041



Caboche  
→ p. 042



Dolmen  
→ p. 043



Index



Filo  
→ p. 044



Giga-Lite  
→ p. 045



Gregg  
→ p. 046



Havana  
→ p. 047



Lumiere XXL  
→ p. 048



Magneto  
→ p. 049



Mite  
→ p. 050



Orbital  
→ p. 051



Tress  
→ p. 052



Tress Stilo  
→ p. 053

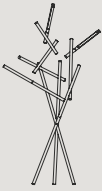

Tuareg  
→ p. 054

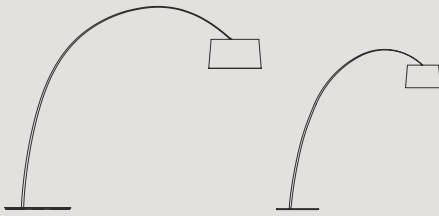

Twice as Twiggy  
→ p. 055

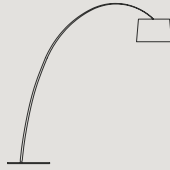

Twiggy  
+LED + MyLight  
→ p. 056-057



Twiggy lettura  
→ p. 058



Allegretto  
→ p. 062



Allegro  
→ p. 063

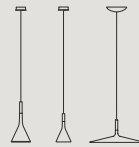

Aplomb  
+ mini + large  
→ p. 064-066

Sospensione →



Arumi  
→ p. 067



Behive  
→ p. 068

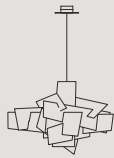

Big Bang + L + XL  
→ p. 070-071



Birdie  
→ p. 069



Buds  
→ p. 072

## Index

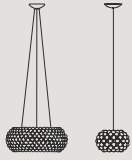

Caboche grande  
+ media + piccola  
→ p. 074-077



Caiigo  
→ p. 082



Chouchin + mini  
+ reverse  
→ p. 078-081

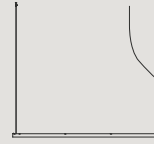

Dolmen  
→ p. 083



Gem  
→ p. 084



Giga-Lite  
→ p. 085



Gregg  
→ p. 086



Havana  
→ p. 088



Le Soleil  
→ p. 089



Lightweight  
→ p. 091



Maki  
→ p. 092



O-space  
→ p. 093



Plass grande  
+ media  
→ p. 094-095



Plena  
+ Plena MyLight  
→ p. 098

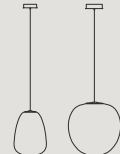

Rituals + Rituals XL  
→ p. 096-097



Satellight  
→ p. 099

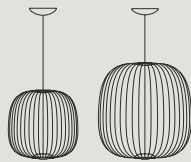

Spokes  
+ Spokes 2 large  
→ p. 100-102



Supernova  
→ p. 103



Tartan  
→ p. 104



Tite  
→ p. 105

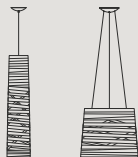

Tress + grande  
→ p. 106-108



Tress stilo  
→ p. 109

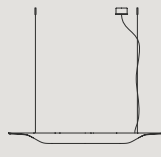

Troag  
→ p. 110

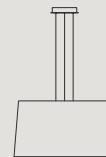

Twice as Twiggy  
→ p. 113



Twiggy  
→ p. 111

## Index



Uto  
→ p. 114



Bahia + Bahia mini  
→ p. 128



Big Bang  
→ p. 129

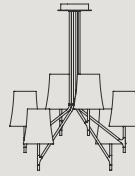

Birdie 3 - 6 - 9  
→ p. 130



Blob S  
→ p. 132

## Soffitto →



Caboche  
→ p. 133



Circus  
→ p. 134



Folio  
→ p. 135



Gregg  
→ p. 136



Lumiere XXL + XXS  
→ p. 137

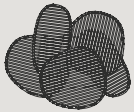

Nuage  
→ p. 138



Rituals  
→ p. 139



Superficie  
→ p. 140



Twiggy  
→ p. 141



Aplomb  
→ p. 144



Bahia + Bahia mini  
→ p. 145

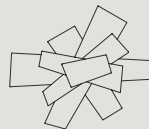

Big Bang  
→ p. 146

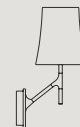

Birdie  
→ p. 147

## Parete →

## Index



Bit  
→ p. 148



Blob S  
→ p. 149

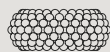

Caboche  
→ p. 150



Circus  
→ p. 151



Double  
→ p. 152

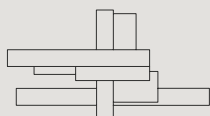

Fields  
→ p. 153



Filo  
→ p. 154



Folio  
→ p. 155



Gregg  
→ p. 156



Havana  
→ p. 157



Innerlight  
→ p. 158



Kite  
→ p. 159



Lake  
→ p. 160



Le Soleil  
→ p. 161



Lumiere XXL + XXS  
→ p. 162

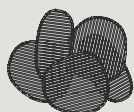

Nuage  
→ p. 163



Rituals  
→ p. 164



Satellight  
→ p. 165



Superficie  
→ p. 166



Tress  
→ p. 167



Tutù  
→ p. 168

## Index

## Esterno →



Cri Cri  
→ p. 172



Gregg outdoor terra  
→ p. 173



Twiggy Grid XL  
→ p. 177



Havana outdoor terra  
→ p. 174



Solar outdoor  
→ p. 175

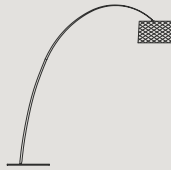

Twiggy Grid  
→ p. 176



Twiggy Grid lettura  
→ p. 177



Aplomb sospensione  
→ p. 178



Gregg outdoor sospensione  
→ p. 179



Havana outdoor sospensione  
→ p. 180



Twiggy Grid  
→ p. 181



Uto sospensione  
→ p. 182



Gregg MIDI parete / soffitto  
→ p. 183



Rosone tondo  
→ p. 116

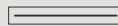

Rosone lineare L 90  
→ p. 116

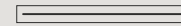

Rosone lineare L 135  
→ p. 117

## Accessori →



Kit decentramento  
→ p. 124



MyLight Collection  
→ p. 184

LED + DIMMING  
→ p. 185



INFO  
→ p. 186



Packing  
→ p. 188

## Legenda



### LED

It marks the models with integrated LED included in the lamp, which is the result of Foscarini designing and engineering.



### ENEC

The label ENEC (Electrical Certification concerning European Standard) is a voluntary label granted by third organizations. It certifies that a product complies with the EN 60598 standards and has been designed and manufactured by companies with an approved UNI EN ISO 9001 quality control system.



Declares that the manufacturer produces light fittings which comply with the requirements of the EN 60598.



### Classe I

Class I° luminaire: it's necessary to connect the device to the yellow/green protective conductor (earthing).



### Classe II

Light fittings whose safety is guaranteed only by the double and/or reinforced insulation of all parts, with no earth.



### Class III

Appliance in which protection against electrical shock is guaranteed by the extremely low-voltage power supply and which does not produce higher voltages.



### IP Protection Degree

/P20: protected against the penetration of solid objects greater than 12 mm and non protected against liquids.  
IP44: protected against the penetration of solid objects greater than 1 mm and protected against splashing water.  
IP65: dust-tight and protected against water jets.

### Energy efficiency classes

The energy efficiency classes for light appliances set out by EU regulation no. 874/2012 are calculated on the basis of the Energy Efficiency Index (EEI) and range between A++ (maximum efficiency) and E (minimum efficiency).



### Dimmer

Please verify the compatibility of your bulb with the dimmer's wattage ranges, indicated on the dimmer itself, according to the kind of light source.

### Azienda certificata

UNI EN ISO 9001:2015  
UNI EN ISO 14001:2015

### CSQ - IQNET

The CSQ-IQNET label is valid all over the world. It certifies that Foscarini runs a quality management system which complies with the UNI EN ISO 9001:2008 standard, to guarantee a high quality level for what concerns project, development, production and distribution of its products.

### CSQ ECO

*This label is valid all over the world.* It certifies that Foscarini runs an environmental management system which complies with the UNI EN ISO 14001:2004 standard in order to guarantee company's commitment to continual improvement of its environmental performances.

## Excerpt from sales conditions

1. Our prices are net ex works.
2. The prices include: carton packaging, transformers for low tensions. Prices do not include bulbs, if not differently stated.
3. The prices here contained refer to materials complying with the technical standards of the market this price list is meant for. Any request for material complying with other standards shall be quoted separately.
4. Goods are carefully inspected and accurately packed before shipment, Foscarini Spa therefore declines any liability for transport damages.
5. The goods are dispatched at the buyer's risk, even if sent free domicile.
6. Claims must be notified by registered mail addressed to our head offices within 3 days from receipt of the goods.
7. Any litigation falls within cognisance of Venice Italy Law-Court.
8. Dimensions and colours indicated have a tolerance due to the characteristic handwork of materials.
9. This price list can be subject to alteration without any notice.
10. Products images and configurations may vary from price book, catalogues and website from the actual merchandise, including but not limited to cords, cables, color, price, dimension, descriptions, details, dimmer.
11. Foscarini reserves the property of the goods until full payment of the same.
12. Prices are expressed in Euro vat excluded.
13. This price list replaces any previous one.

## iFoscarini app

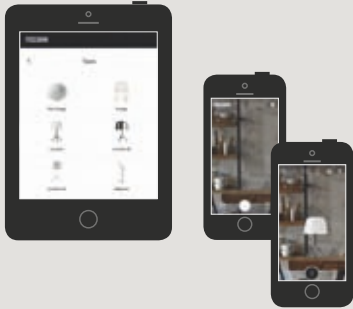

iFoscarini an app designed for all design enthusiasts who wish to customise their surroundings with the unmistakable personality of Foscarini models.

With captivating and emotional graphics and extremely user-friendly it allows users to insert lamps in rooms and settings which are caught on camera each time or picked from an archive of pictures. Available on the Apple Store and Play Store the iFoscarini app is a very effective tool that is extremely simple to use.

## Social media



Foscarini is present on all the main social networks with systems and languages suited to each individual channel and type of user:

- Facebook to create and maintain public relations, communicate news and projects, share news, images and films;
- Instagram to view projects and stimulate users to create images with Foscarini models.
- Twitter publicise events, initiatives, news and links in brief, high impact messages;
- Pinterest to share images of Foscarini models and initiatives, subdividing them into theme boards;
- Linkedin to create and maintain relationships with sector operators and share professional contents

## myFoscarini



With the same spirit that provides new ideas in lighting design, Foscarini creates its own more efficient programs for customer and partner communication, for instance, myFoscarini, a proprietary platform, an absolutely innovative, highly flexible and transparent tool providing customers with complete information and full range of functions. With just a few clicks in my foscarini you can:

- check the availability of lamps and the shipping date
- Enter your orders, reserving lamps directly from Foscarini's central system

- track your order status
- consult sale conditions;
- download admin documents such as transport documents and invoices;
- prepare a quotation;
- download: images, logos, PDF and excel price lists assembly instructions, certifications and energy labels. And all this 7 days a week, 24 hours a day. If you haven't registered yet request your password from Foscarini Customer Care.



FOSCARINI INTRODUCES

# Lights that change everything

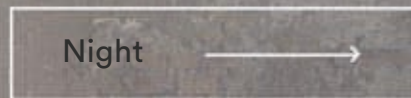
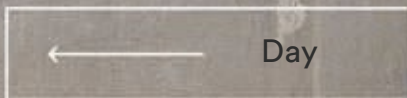

VIEW ALL PRODUCTS



Visit our new website: [www.foscarini.com](http://www.foscarini.com)



Tavolo, *Table*014 **Anisha**015 **Behive**018 **Binic**016 **Birdie**017 **Birdie LED**019 **Buds**020 **Caboche**021 **Filo**022 **Gem**023 **Gregg**028 **Kurage**024 **Lumiere**026 **Lumiere 25<sup>th</sup>**027 **Lumiere XX**029 **Magneto**030 **Plass media**031 **Poly Gregg**032 **Rituals**034 **Satellight**035 **Soffio**036 **Twiggy XL**037 **Uto**

## Anisha

Lievore Altherr Molina,  
2011



	energy cl.	colours	code	€ vat excluded
<i>Anisha grande</i>	A <sup>+</sup>	bianco	213001R1 10	360,00
<i>Anisha piccola</i>	A <sup>+</sup>	bianco	2130012R1 10	287,00

Injection moulded ABS

*Anisha grande*  
LED included  
Power LED 4,5W 3000 K  
400 lm CRI>80  
Integrated touch dimmer

*Anisha piccola*  
LED included  
Power LED 3,4W 3000 K  
300 lm CRI>80  
Integrated touch dimmer

With personalized packaging



Colours: bianco



Weight:  
*Anisha grande*  
net kg 0,70

*Anisha piccola*  
net kg 0,40

Tecnico — 2019

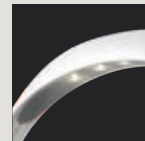
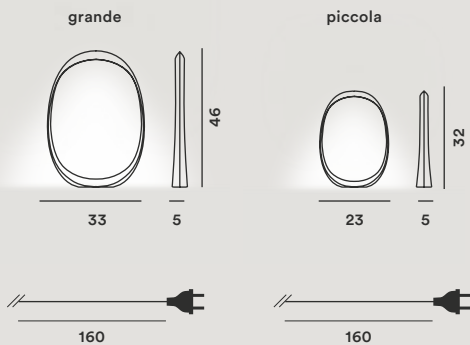

## Behive

Werner Aisslinger, 2011



	energy cl.	colours	code	€ vat excluded
<i>Behive</i>	A+, A	bianco	203001 10	428,00
<b>Spare parts:</b>				
<i>Lampshade Behive</i>		bianco	203S00 10	195,00
<i>Protection glass</i>			203V01/I	51,00

Batch-dyed ABS,  
polycarbonate and coated  
metal

Max 1x150W E27  
Dimmer included



Please verify the  
compatibility of your bulb  
with the dimmer's wattage  
ranges, indicated on the  
dimmer itself, according to  
the kind of light source.

□ CE IP 20

Colours: bianco



Weight:  
net kg 3,70

Light bulbs not included  
→ specifications p. 186

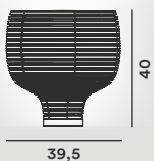

collection →



p. 068

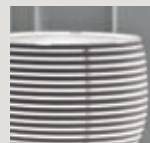

**Birdie**

Ludovica + Roberto  
Palomba, 2011



Polycarbonate, varnished  
steel and metal

*Birdie grande on/off*  
Max 1x150W E27

*Birdie grande  
with integrated touch dimmer*  
Halo or dimmable LED  
retrofit Max 1x150 E27

*Birdie piccola on/off*  
LED retrofit or Fluo  
Max 1x70W E27

*Birdie piccola  
with integrated touch dimmer*  
Dimmable LED retrofit or  
Halo Max 1x70W E27

☐ CE IP 20

	energy cl.	colours	code	€ vat excluded
<i>Birdie grande on/off</i>	A+, A	bianco	221001S 10	280,00
		grigio	221001S 25	
		arancio	221001S 53	
		amaranto	221001S 65	
<i>Birdie grande with touch dimmer</i>	A+, A	bianco	221001 10	339,00
		grigio	221001 25	
		arancio	221001 53	
		amaranto	221001 65	
<i>Birdie piccola on/off</i>	A+, A	bianco	2210012 10	238,00
		grigio	2210012 25	
		arancio	2210012 53	
		amaranto	2210012 65	
<i>Birdie piccola with touch dimmer</i>	A+, A	bianco	2210012DM 10	291,00
		grigio	2210012DM 25	
		arancio	2210012DM 53	
		amaranto	2210012DM 65	
<b>Spare parts:</b>				
<i>Lampshade Birdie grande</i>		bianco	221S00 10	66,00
		grigio	221S00 25	
		arancio	221S00 53	
		amaranto	221S00 65	
<i>Lampshade Birdie piccola</i>		bianco	221S002 10	47,00
		grigio	221S002 25	
		arancio	221S002 53	
		amaranto	221S002 65	

Colours: bianco, grigio,  
arancio, amaranto



Weight:  
*Birdie grande*  
net kg 4,00

*Birdie piccola*  
net kg 2,00

Light bulbs not included  
→ specifications p. 186

grande

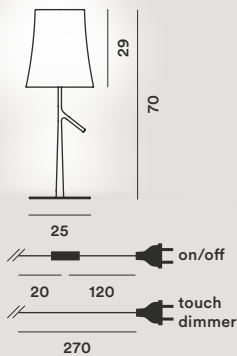

piccola

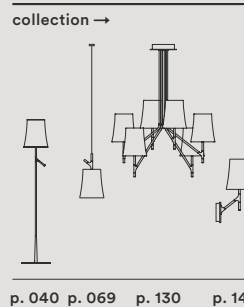
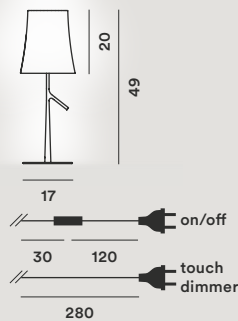

## Birdie LED

Ludovica + Roberto  
Palomba, 2011

LED



Polycarbonate, varnished  
steel and metal

LED included  
Mid power 8,4 W 2700 K  
655 lm CRI>80

CE IP 20

	energy cl.	colours	code	€ vat excluded
<i>Birdie LED grande</i> <i>with touch dimmer</i>	A <sup>+</sup>	grafite	221001L-22	535,00
		verde acqua	221001L-42	
		rame	221001L-80	
<i>Birdie LED piccola</i> <i>with touch dimmer</i>	A <sup>+</sup>	grafite	2210012L-22	423,00
		verde acqua	2210012L-42	
		rame	2210012L-80	

Colours: grafite,  
verde acqua, rame.

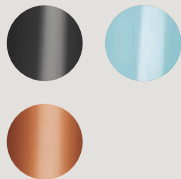

Weight:  
*Birdie grande*  
net kg 4,00

*Birdie piccola*  
net kg 2,00

grande

piccola

rame / grafite

verde acqua

rame / grafite

verde acqua

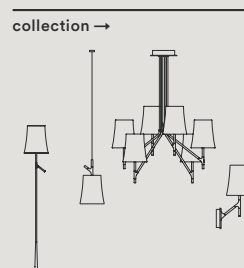
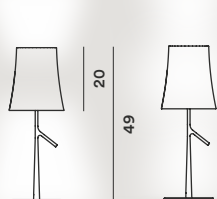
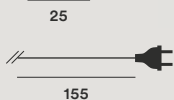
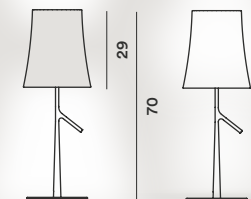

p. 040 p. 069 p. 130 p. 147

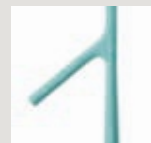
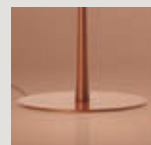

## 018 Tavolo, Table

### Binic

Ionna Vautrin, 2010

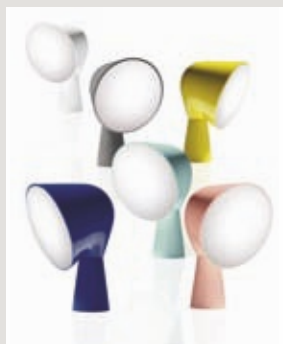

	energy cl.	colours	code	€ vat excluded
<i>Binic</i>	A+, A	bianco	20000110	124,00
		antracite	20000127	
		verde acqua	20000142	
		giallo	20000155	
		rosa	20000161	
		blu	20000187	

Batch-dyed ABS and polycarbonate

Max 1x12W E14

With personalized packaging

☐ CE IP 20

Colours: bianco, antracite, Weight:  
verde acqua, giallo, net kg 0,60  
rosa, blu

Light bulbs not included  
→ specifications p. 186



Tecnico — 2019

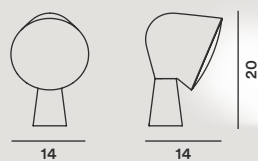



## Buds

Rodolfo Dordoni, 2016



	energy cl.	colours	code	€ vat excluded
<b>Buds 1</b>	A <sup>+</sup> , A	bianco caldo	278011 12	746,00
<b>Buds 2</b>	A <sup>+</sup> , A	bianco caldo	278012 12	776,00
		grigio	278012 24	
<b>Buds 3</b>	A <sup>+</sup> , A	bianco caldo	278013 12	710,00
		verde	278013 40	
<b>Spare parts:</b>				
<b>Glass Buds 1</b>		bianco caldo	278S001 12	356,00
<b>Glass Buds 2</b>		bianco caldo	278S002 12	386,00
		grigio	278S002 24	
<b>Glass Buds 3</b>		bianco caldo	278S003 12	328,00
		verde	278S003 40	

Blown glass and PMMA

Max 1x23W E27  
Ø 9-12 cm

Recommended white globe  
bulb

Ø 12 cm for Buds 1-2  
Ø 9 cm for Buds 3

CE IP 20

Colours:

**Buds 1** bianco caldo  
**Buds 2** bianco caldo,  
grigio  
**Buds 3** bianco caldo,  
verde bambù

Weight:

**Buds 1**  
net kg 4,90  
**Buds 2**  
net kg 6,20  
**Buds 3**  
net kg 4,20

Light bulbs not included

→ specifications p. 186

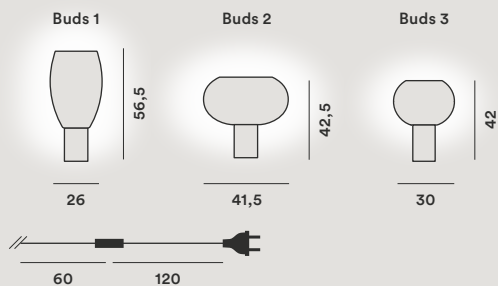

collection →

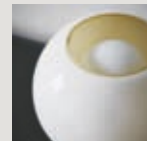

## 020 Tavolo, Table

### Caboche

Patricia Urquiola con  
Elia Gerotto, 2005



PMMA, blown glass and  
coated aluminium

Max 1x48W G9  
Dimmer included



Please verify the  
compatibility of your bulb  
with the dimmer's wattage  
ranges, indicated on the  
dimmer itself, according to  
the kind of light source.

☐ CE IP 20

	energy cl.	colours	code	€ vat excluded
<b>Caboche</b>	A+, A, C	trasparente	138012 16	509,00
		giallo oro	138012 52	
<b>Spare parts:</b>				
<b>Kit 10 spheres Caboche</b>		trasparente	138KIT 10SF16	40,00
		giallo oro	138KIT 10SF52	
<b>Kit 10 prongs 3 sphere Caboche tavolo</b>			138KIT 10P3	25,00
<b>Kit 10 prongs 4 sphere Caboche tavolo</b>			138KIT 10P4	25,00
<b>Kit 3+3 prongs 3-4 sphere Caboche tavolo</b>			138KIT2-R2	18,00
<b>Glass Caboche tavolo</b>			138V012/I	43,00

Colours: trasparente,  
giallo oro

Weight:  
net kg 5,30

Light bulbs not included  
→ specifications p. 186

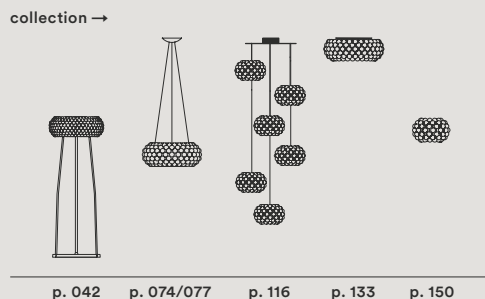
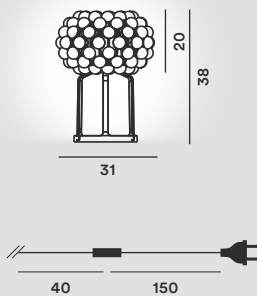
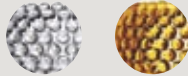

**Filo**

Andrea Anastasio, 2017



	energy cl.	colours	code	€ vat excluded
<i>Filo</i>	A <sup>+</sup>	amethyst queen	289001-01	318,00
		eastern coral	289001-02	
		koh-i-noor	289001-03	
		teodora	289001-04	
		souther talisman	289001-05	
		ruby jaypure	289001-06	
		izmir	289001-07	
		emerald king	289001-08	

Porcelain, blown glass and coated metal

LED retrofit included  
4W G9 3000 K  
400 lm CRI>80



**Colours:**

*Amethyst Queen*



*Eastern Coral*



**Weight:**  
net kg 4,20

*Koh-i-noor*

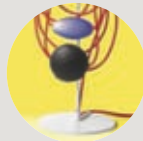

*Teodora*

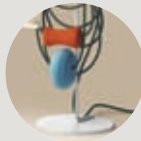

*Southern Talisman*

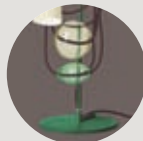

*Ruby Jaypure*

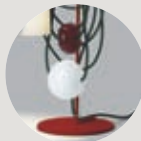

*Izmir*



*Emerald King*

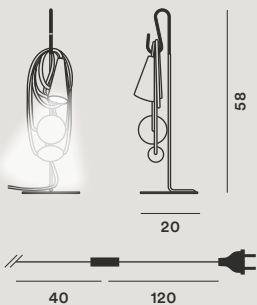
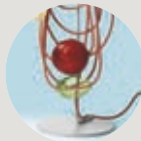

collection →

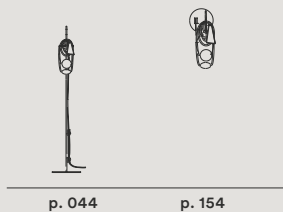

**Gem**

Ludovica + Roberto  
Palomba, 2017



Blown acid-etched glass  
with reliefs, gold-plating  
satin metal

Max 1x150W E27  
Dimmer included



Please verify the  
compatibility of your bulb  
with the dimmer's wattage  
ranges, indicated on the  
dimmer itself, according to  
the kind of light source.

□ CE IP 20

	energy cl.	colours	code	€ vat excluded
<b>Gem</b>	A+, A	bianco	274001-10	688,00
<b>Spare parts:</b>				
<b>Glass Gem</b>		bianco	274S00-10	251,00

Colours: bianco



Weight:  
net kg 6,00

Light bulbs not included  
→ specifications p. 186

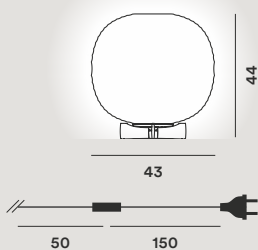

collection →



## Gregg

Ludovica + Roberto  
Palomba, 2007

LED



Blown acid-etched glass and  
coated metal

*Gregg grande - media*  
Max 1x150W E27

*Gregg MIDI*  
LED inclusi COB 8,5W  
2700 K 850 lm CRI>80  
Dimmer included

*Gregg piccola*  
Max 1x25W G9



Please verify the  
compatibility of your bulb  
with the dimmer's wattage  
ranges, indicated on the  
dimmer itself, according to  
the kind of light source.

CE IP 20

	energy cl.	colours	code	€ vat excluded
<i>Gregg grande on/off</i>	A <sup>+</sup> , A	bianco	1680011S 10	533,00
<i>Gregg grande w. dimmer</i>	A <sup>+</sup> , A		1680011 10	553,00
<i>Gregg media on/off</i>	A <sup>+</sup> , A	bianco	168001S 10	315,00
<i>Gregg media w. dimmer</i>	A <sup>+</sup> , A		168001 10	335,00
<i>Gregg MIDI</i>	A	bianco	1680013-10	255,00
<i>Gregg piccola on/off</i>	A <sup>+</sup> , A, C	bianco	1680012S 10	148,00
<i>Gregg piccola w. dimmer</i>	A <sup>+</sup> , A, C		1680012 10	178,00

### Spare parts:

<i>Glass Gregg grande</i>	bianco	168S001 10	334,00
<i>Glass Gregg media</i>	bianco	168S00 10	180,00
<i>Glass Gregg MIDI</i>	bianco	168S003-10	91,00
<i>Glass Gregg piccola</i>	bianco	168S00210	60,00

Colours: bianco



Weight:

*Gregg grande*  
net kg 6,80

*Gregg media*  
net kg 3,30

*Gregg MIDI*  
net kg 1,60

*Gregg piccola*  
net kg 0,60

Light bulbs not included

→ specifications p. 186

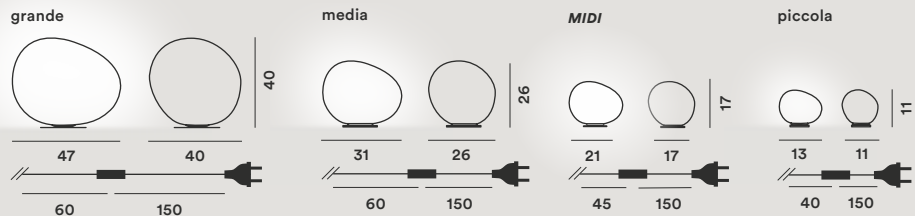

collection →

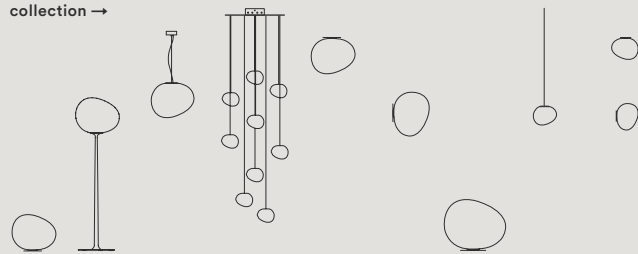

p. 031 p. 046 p. 084 p. 116 p. 136 p. 156 p. 173 p. 179 p. 183

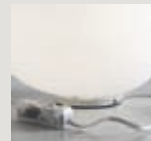

**Lumiere grande**

Rodolfo Dordoni, 1990

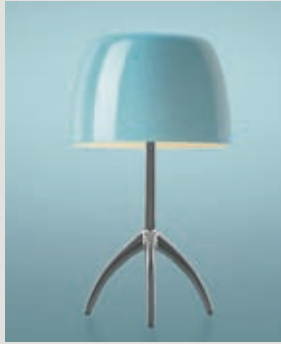

Blown glass and polished or painted brushed aluminum

*Lumiere grande*  
Max 2x48W G9



Please verify the compatibility of your bulb with the dimmer's wattage ranges, indicated on the dimmer itself, according to the kind of light source.



	energy cl.	colours	code	€ vat excluded
<i>Lumiere grande on/off</i>	A+, A, C	alluminio/bianco	026001R2 11	450,00
		all./bianco caldo	026001R2 12	511,00
		all./turchese	026001R2 32	
		all./ciliegia	026001R2 62	
<i>Lumiere grande on/off</i>	A+, A, C	cromo nero/bianco	026011R2 11	450,00
		c. nero/bianco caldo	026011R2 12	511,00
		c. nero/turchese	026011R2 32	
		c. nero/ciliegia	026011R2 62	
<i>Lumiere grande on/off</i>	A+, A, C	champagne/bianco	026021R2 11	450,00
		cham./bianco caldo	026021R2 12	511,00
		cham./turchese	026021R2 32	
		cham./ciliegia	026021R2 62	
<i>Lumiere grande with dimmer</i>	A+, A, C	alluminio/bianco	026001R2 11 D	481,00
		all./bianco caldo	026001R2 12 D	542,00
		all./turchese	026001R2 32 D	
		all./ciliegia	026001R2 62 D	
<i>Lumiere grande with dimmer</i>	A+, A, C	cromo nero/bianco	026011R2 11 D	481,00
		c. nero/bianco caldo	026011R2 12 D	542,00
		c. nero/turchese	026011R2 32 D	
		c. nero/ciliegia	026011R2 62 D	
<i>Lumiere grande with dimmer</i>	A+, A, C	champagne/bianco	026021R2 11 D	481,00
		cham./bianco caldo	026021R2 12 D	542,00
		cham./turchese	026021R2 32 D	
		cham./ciliegia	026021R2 62 D	
<b>Spare parts:</b>				
<i>Glass Lumiere grande</i>		bianco	026S00 11	190,00
		bianco caldo	026S00 12	251,00
		turchese	026S00 32	
		ciliegia	026S00 62	

Glass colours:  
bianco, bianco caldo,  
ciliegia, turchese

Weight:  
net kg 2,40

Light bulbs not included  
→ specifications p. 186

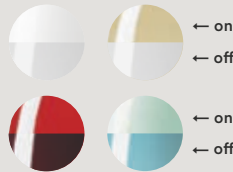

Frame colours:  
alluminio, cromo nero,  
champagne



collection →

Tecnico — 2019

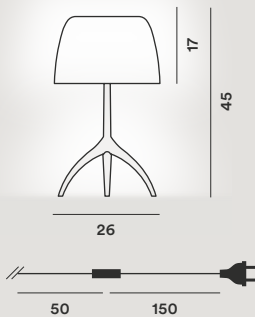

**Lumiere piccola**

Rodolfo Dordoni, 1990



Blown glass and polished or painted brushed aluminum

*Lumiere piccola*  
Max 1x42W G9



Please verify the compatibility of your bulb with the dimmer's wattage ranges, indicated on the dimmer itself, according to the kind of light source.

☐ CE IP 20

	energy cl.	colours	code	€ vat excluded
<i>Lumiere piccola on/off</i>	A <sup>+</sup> , A, C	alluminio/bianco	0260012R2 11	309,00
		all./bianco caldo	0260012R2 12	366,00
		all./turchese	0260012R2 32	
		all./ciliegia	0260012R2 62	
<i>Lumiere piccola on/off</i>	A <sup>+</sup> , A, C	cromo nero/bianco	0260112R2 11	309,00
		c. nero/bianco caldo	0260112R2 12	366,00
		c. nero/turchese	0260112R2 32	
		c. nero/ciliegia	0260112R2 62	
<i>Lumiere piccola on/off</i>	A <sup>+</sup> , A, C	champagne/bianco	0260212R2 11	309,00
		cham./bianco caldo	0260212R2 12	366,00
		cham./turchese	0260212R2 32	
		cham./ciliegia	0260212R2 62	
<i>Lumiere piccola with dimmer</i>	A <sup>+</sup> , A, C	alluminio/bianco	0260012R2 11D	340,00
		all./bianco caldo	0260012R2 12D	397,00
		all./turchese	0260012R2 32D	
		all./ciliegia	0260012R2 62D	
<i>Lumiere piccola with dimmer</i>	A <sup>+</sup> , A, C	cromo nero/bianco	0260112R2 11D	340,00
		c. nero/bianco caldo	0260112R2 12D	397,00
		c. nero/turchese	0260112R2 32D	
		c. nero/ciliegia	0260112R2 62D	
<i>Lumiere piccola with dimmer</i>	A <sup>+</sup> , A, C	champagne/bianco	0260212R2 11D	340,00
		cham./bianco caldo	0260212R2 12D	397,00
		cham./turchese	0260212R2 32D	
		cham./ciliegia	0260212R2 62D	
<b>Spare parts:</b>				
<i>Glass Lumiere piccola</i>		bianco	026S002R 11	108,00
		bianco caldo	026S002R 12	165,00
		turchese	026S002R 32	
		ciliegia	026S002R 62	

**Glass colours:**  
bianco, bianco caldo,  
ciliegia, turchese

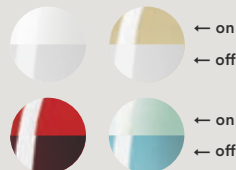

**Weight:**  
net kg 1,10

**Light bulbs not included**  
→ specifications p. 186

**Frame colours:**  
alluminio, cromo nero,  
champagne



collection →

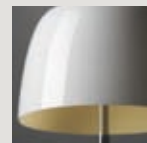
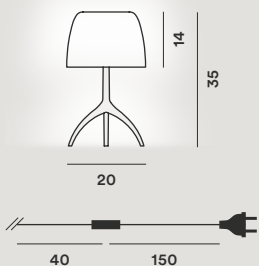

**Lumiere 25<sup>th</sup>**

Rodolfo Dordoni,  
1990/2015



Blown mirrored glass and polished or varnished aluminium

*Lumiere 25<sup>th</sup> grande*  
Max 2x48W G9

*Lumiere 25<sup>th</sup> piccola*  
Max 1x42W G9



Please verify the compatibility of your bulb with the dimmer's wattage ranges, indicated on the dimmer itself, according to the kind of light source.



	energy cl.	colours	code	€ vat excluded
<i>Lumiere 25<sup>th</sup> grande</i>	A <sup>+</sup> , A, C	alluminio/25 <sup>th</sup>	026001R2 30	679,00
		cromo nero/25 <sup>th</sup>	026011R2 30	
		champagne/25 <sup>th</sup>	026021R2 30	
<i>Lumiere 25<sup>th</sup> grande with dimmer</i>	A <sup>+</sup> , A, C	alluminio/25 <sup>th</sup>	026001R2 30 D	710,00
		cromo nero/25 <sup>th</sup>	026011R2 30 D	
		champagne/25 <sup>th</sup>	026021R2 30 D	
<i>Lumiere 25<sup>th</sup> piccola</i>	A <sup>+</sup> , A, C	alluminio/25 <sup>th</sup>	0260012R2 30	516,00
		cromo nero/25 <sup>th</sup>	0260112R2 30	
		champagne/25 <sup>th</sup>	0260212R2 30	
<i>Lumiere 25<sup>th</sup> piccola with dimmer</i>	A <sup>+</sup> , A, C	alluminio/25 <sup>th</sup>	0260012R2 30D	547,00
		cromo nero/25 <sup>th</sup>	0260112R2 30D	
		champagne/25 <sup>th</sup>	0260212R2 30D	

Spare parts:

<i>glass Lumiere 25<sup>th</sup> grande</i>	026S00 30	419,00
<i>glass Lumiere 25<sup>th</sup> piccola</i>	026S002R 30	315,00

Glass colours:  
specchio trasparente



Weight:  
*Lumiere 25<sup>th</sup> grande*  
net kg 2,40

*Lumiere 25<sup>th</sup> piccola*  
net kg 1,10

Light bulbs not included  
→ specifications p. 186

Frame colours:  
alluminio, cromo nero,  
champagne

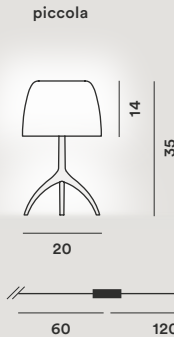
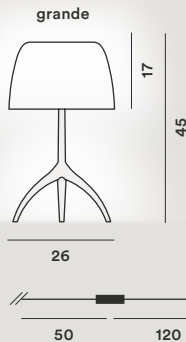

collection →





**Lumiere XXL - XXS**

Rodolfo Dordoni, 2009



Blown glass and polished or painted brushed aluminum

*Lumiere XXL*  
Max 4x33W G9  
Dimmer included

*Lumiere XXS*  
Max 1x42W G9  
Dimmer included



Please verify the compatibility of your bulb with the dimmer's wattage ranges, indicated on the dimmer itself, according to the kind of light source.

CE IP 20

	energy cl.	colours	code	€ vat excluded
<i>Lumiere XXL</i>	A <sup>+</sup> , A, C	alluminio/bianco	191001A 11	763,00
		alluminio/grigio	191001A 24	
		cromo nero/bianco	191001C 11	
		cromo nero/grigio	191001C 24	
<i>Lumiere XXS</i>	A <sup>+</sup> , A, C	alluminio/bianco	1910012A 11	495,00
		alluminio/grigio	1910012A 24	
		cromo nero/bianco	1910012C 11	
		cromo nero/grigio	1910012C 24	
<b>Spare parts:</b>				
<i>Glass Lumiere XXL</i>		bianco	191S001 11	342,00
		grigio	191S001 24	
<i>Glass Lumiere XXS</i>		bianco	191S002 11	206,00
		grigio	191S002 24	

Glass colours:  
bianco, grigio freddo,



Frame colours:  
alluminio, cromo nero



Weight:  
*Lumiere XXL*  
net kg 5,50

*Lumiere XXS*  
net kg 1,80

Light bulbs not included  
→ specifications p. 186

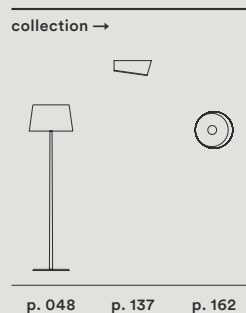
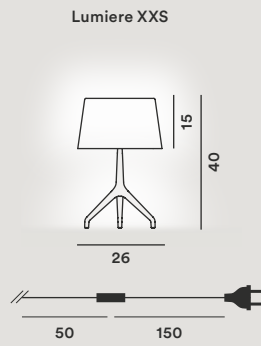
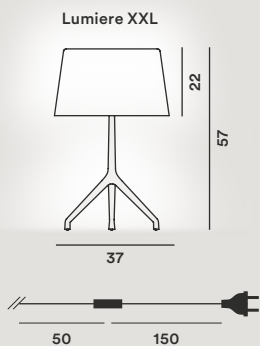

## Kurage

Nichetto + Nendo, 2015



	energy cl.	colours	code	€ vat excluded
<i>Kurage</i>	A+, A	bianco	258001 10	495,00
<b>Spare parts:</b>				
<i>Lampshade Kurage</i>		bianco	258S00 10	171,00

Washi paper and ashwood

Max 1x12W E27

☐ CE IP 20

Colours: bianco



Weight:  
net kg 0,70

Light bulbs not included  
→ specifications p. 186

Tecnico — 2019

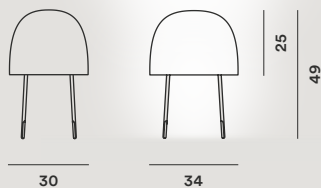

**Magneto**

Giulio Iacchetti, 2011

**LED**

	energy cl.	colours	code	€ vat excluded
<b>Magneto</b>	A <sup>+</sup>	bianco	202001R2 10	317,00
		nero	202001R2 20	

Coated steel, ABS and super magnet made of "rare earth"

Colours: bianco, nero

Weight:  
net kg 1,30



LED included  
Power LED 5W 2700 K  
475 lm CRI>80

With personalized packaging

CE IP 20

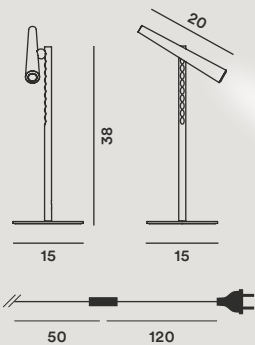

collection →



p. 049



**Plass media**

Luca Nichetto, 2015



	energy cl.	colours	code	€ vat excluded
<i>Plass media on/off</i>	A <sup>+</sup> , A	grigio	2240012 25	388,00
		azzurro	2240012 30	
<i>Plass media with dimmer</i>	A <sup>+</sup> , A	grigio	2240012D 25	410,00
		azzurro	2240012D 30	
<b>Spare parts:</b>				
<i>Lampshade Plass</i>		grigio	224S002R1 25	253,00
		azzurro	224S002R1 30	

Rotational moulded polycarbonate and steel

*Plass media*  
Max 1x150W E27



Please verify the compatibility of your bulb with the dimmer's wattage ranges, indicated on the dimmer itself, according to the kind of light source.

☐ CE ◀ IP 20

Colours: grigio, azzurro

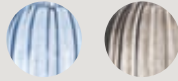

Weight:  
net kg 4,00

Light bulbs not included  
→ specifications p. 186

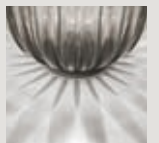
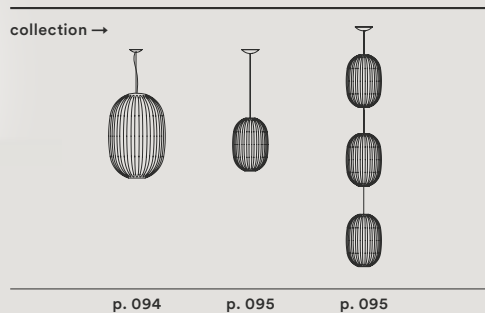
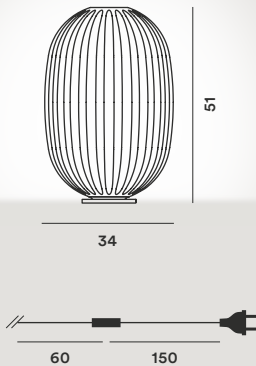

## Poly Gregg

Ludovica + Roberto  
Palomba, 2011



Rotational moulded  
polyethylene

*X-large / grande*  
Max 1x25W E27

*media*  
Max 1x15W E27

☐ CE IP 20

	energy cl.	colours	code	€ vat excluded
<i>Poly Gregg X-large</i>	A <sup>+</sup> , A	bianco	2180030 10	360,00
<i>Poly Gregg grande</i>	A <sup>+</sup> , A	bianco	2180130 10	280,00
<i>Poly Gregg media</i>	A <sup>+</sup> , A	bianco	2180230 10	197,00
<b>Spare parts:</b>				
<i>Lampshade Poly Gregg X-large</i>		bianco	218S001 10	183,00
<i>Lampshade Poly Gregg grande</i>		bianco	218S00 10	103,00
<i>Lampshade Poly Gregg media</i>		bianco	218S002 10	64,00

Colours: bianco



Weight:  
*X-large*  
net kg 4,30

*grande*  
net kg 3,60

*media*  
net kg 1,60

Light bulbs not included  
→ specifications p. 186

X-large

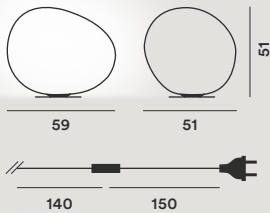

grande

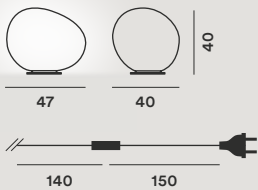

media

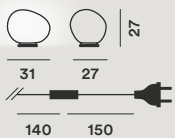

collection →

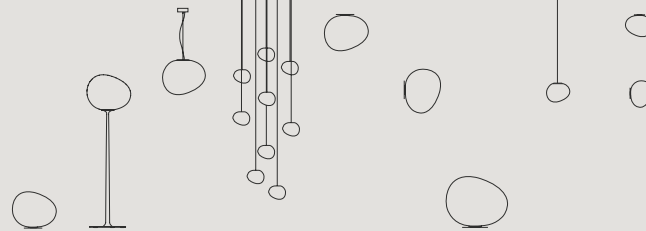

p. 023/026 p. 046 p. 086 p. 116 p. 136 p. 156 p. 173 p. 179 p. 183

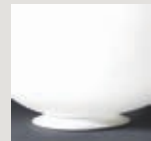

**Rituals + Rituals XL**

Ludovica + Roberto  
Palomba, 2012 - 2015



	energy cl.	colours	code	€ vat excluded
<i>Rituals 1 on/off</i>	A <sup>+</sup> , A	bianco	2440011 10	342,00
<i>Rituals 1 with dimmer</i>	A <sup>+</sup> , A	bianco	2440011D1 10	380,00
<i>Rituals 2 on/off</i>	A <sup>+</sup> , A	bianco	2440012 10	342,00
<i>Rituals 2 with dimmer</i>	A <sup>+</sup> , A	bianco	2440012D1 10	380,00
<i>Rituals 3 on/off</i>	A <sup>+</sup> , A	bianco	2440013 10	286,00
<i>Rituals 3 with dimmer</i>	A <sup>+</sup> , A	bianco	2440013D1 10	324,00

Blown engraved satin glass  
and coated metal

Colours: bianco



Weight:  
*Rituals 1*  
net kg 4,00

Light bulbs not included  
→ specifications p. 186

*Rituals 1-2-3*  
Max 1x105W E27

*Rituals 2*  
net kg 4,10

*Rituals XL*  
Max 1x150W E27

*Rituals 3*  
net kg 1,60



Please verify the  
compatibility of your bulb  
with the dimmer's wattage  
ranges, indicated on the  
dimmer itself, according to  
the kind of light source.

*Rituals XL*  
net kg 6,60

□ CE IP 20

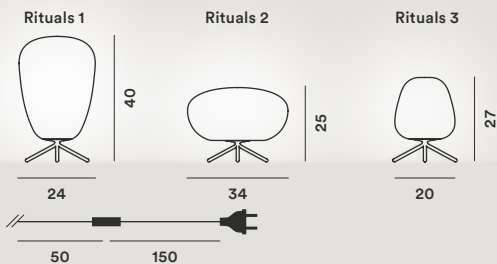

collection →

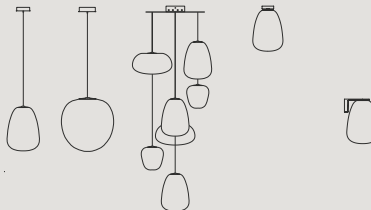

	energy cl.	colours	code	€ vat excluded
<i>Rituals XL on/off</i>	A <sup>+</sup> , A	bianco	2440014 10	511,00
<i>Rituals XL with dimmer</i>	A <sup>+</sup> , A	bianco	2440014D 10	531,00

## Spare parts:

<i>Glass Rituals 1</i>		bianco	244S001 10	226,00
<i>Glass Rituals 2</i>		bianco	244S002 10	226,00
<i>Glass Rituals 3</i>		bianco	244S003 10	170,00
<i>Glass Rituals XL</i>		bianco	244S004 10	331,00

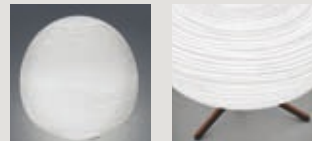
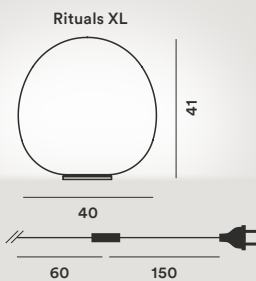

## Satellight

Eugeni Quitllet, 2017



	energy cl.	colours	code	€ vat excluded
<b>Satellight on/off</b>	A <sup>+</sup>	bianco/trasp.	285021-15	390,00
<b>Satellight with touch dimmer</b>	A <sup>+</sup>	bianco/trasp.	285021D-15	437,00
<b>Spare parts:</b>				
<b>External glass</b>		trasparente	285RV011-15	237,00
<b>Inner glass</b>		bianco	285RV012-10	66,00

Blown glass

LED included  
Mid power 8W 2700 K  
957 lm CRI>90

☐ CE IP 20

Colours:  
bianco/trasparente

Weight:  
net kg 2,5

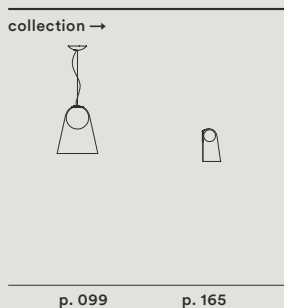
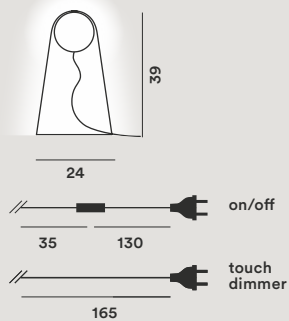



035

## Soffio

Ludovica + Roberto  
Palomba, 2018

LED



	energy cl.	colours	code	€ vat excluded
<i>Soffio</i>	A <sup>+</sup>	bianco sfumato	300001A-10	615,00

Blown glass and aluminium.

Colours: trasparente  
and bianco sfumato

Weight:  
net kg 3,10

LED included  
Mid power 13,8 W 2700 K  
1300 lm CRI>80  
Integrated touch dimmer



CE IP 20

30



50

15



165



30



## Twiggy XL

Marc Sadler, 2008



	energy cl.	colours	code	€ vat excluded
<b>Twiggy XL •</b>	A <sup>+</sup> , A	bianco	1590011 10	762,00
		nero	1590011 20	
<b>Spare parts:</b>				
<b>Lampshade Twiggy XL</b>		bianco	159S10 10	473,00
		nero	159S10 20	

Varnished fibreglass-based composite material, polycarbonate and varnished metal

Colours: bianco, nero

Weight:  
net kg 6,80

Light bulbs not included  
→ specifications p. 186



Max 3x150W E27  
Dimmer included



Please verify the compatibility of your bulb with the dimmer's wattage ranges, indicated on the dimmer itself, according to the kind of light source.

•  
**On demand:**  
lead times to be checked with the sales department

☐ CE IP 20

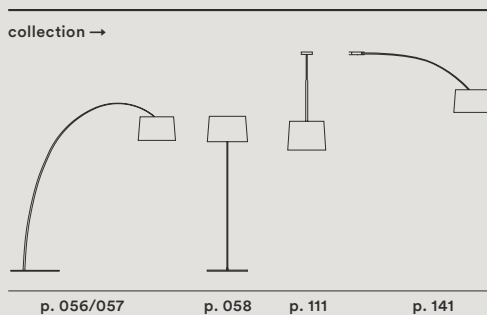
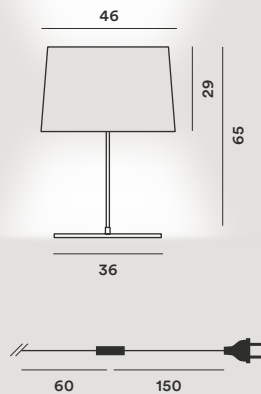

**Uto**

Lagranja Design, 2005



	energy cl.	colours	code	€ vat excluded
<i>Uto</i>	A <sup>+</sup> , A	bianco	142000 10	356,00
		giallo	142000 50	
		arancio	142000 53	

Thermoplastic elastomer and polycarbonate

Max 1x12W E27

Switch inside the flexible tube

CE IP 44

Colours: bianco, giallo, arancio



Weight: net kg 2,00

Light bulbs not included  
→ specifications p. 186

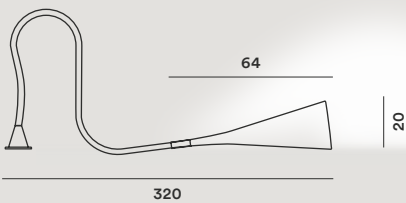

collection →

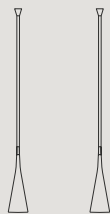

p. 114

p. 182



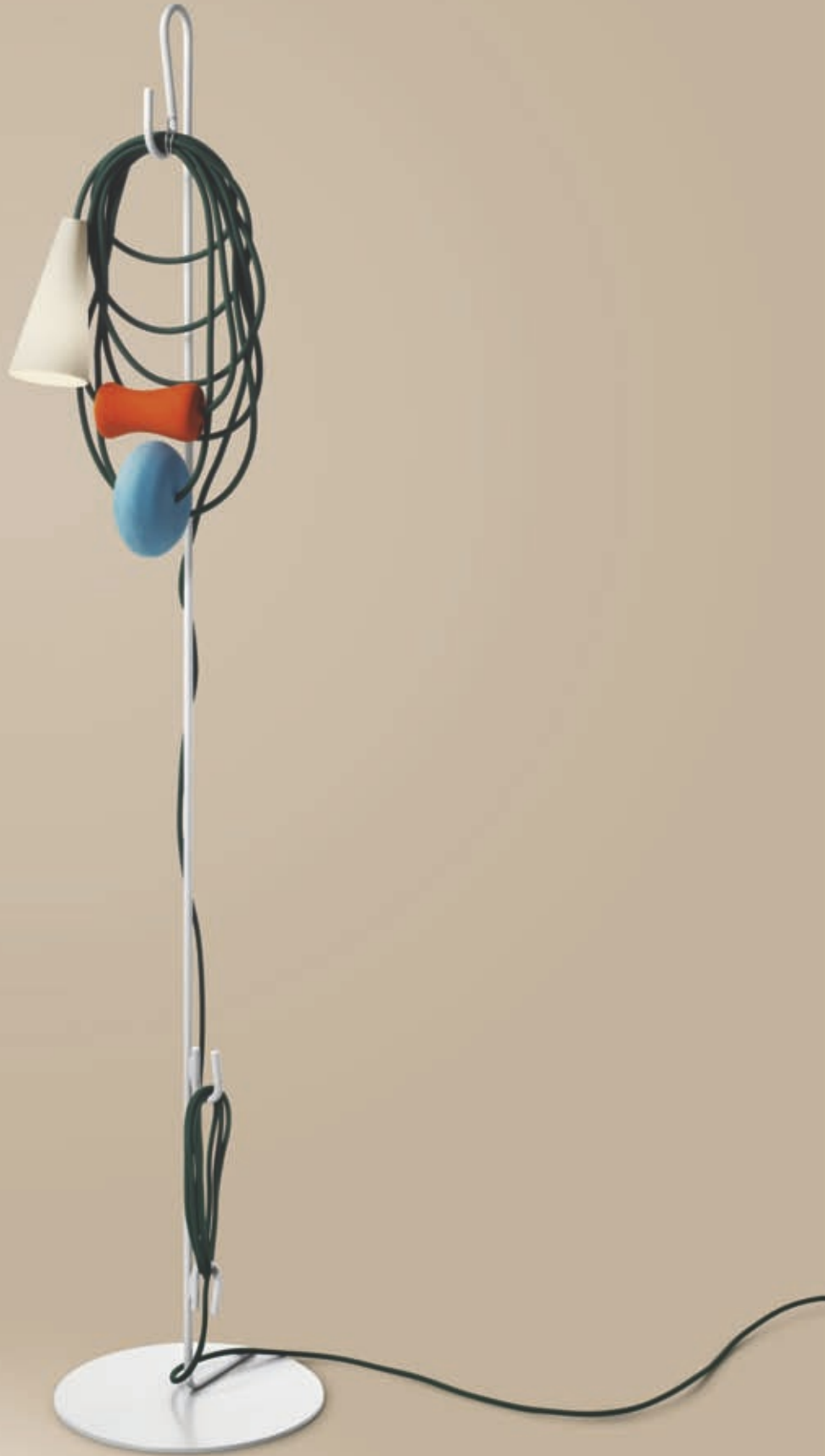

## Terra, Floor

- |     |                    |     |                              |
|-----|--------------------|-----|------------------------------|
| 040 | <b>Birdie</b>      | 050 | <b>Mite</b>                  |
| 041 | <b>Birdie LED</b>  | 051 | <b>Orbital</b>               |
| 042 | <b>Caboche</b>     | 052 | <b>Tress</b>                 |
| 043 | <b>Dolmen</b>      | 053 | <b>Tress Stilo</b>           |
| 044 | <b>Filo</b>        | 054 | <b>Tuareg</b>                |
| 045 | <b>Giga-Lite</b>   | 055 | <b>Twice</b>                 |
| 046 | <b>Gregg</b>       |     | <b>as Twiggy</b>             |
| 047 | <b>Havana</b>      | 056 | <b>Twiggy</b>                |
| 048 | <b>Lumiere XXL</b> | 057 | <b>Twiggy <i>MyLight</i></b> |
| 049 | <b>Magneto</b>     | 058 | <b>Twiggy <i>lettura</i></b> |

## Birdie

Ludovica + Roberto  
Palomba, 2011



Polycarbonate, coated steel  
and metal

*Birdie lettura on/off*  
Max 1x150W E27

*Birdie lettura with integrated  
touch dimmer*  
Halo or dimmable LED  
retrofit Max 1x150 E27

☐ CE IP 20

	energy cl.	colours	code	€ vat excluded
<i>Birdie lettura on/off</i>	A <sup>+</sup> , A	bianco	221004S 10	331,00
		grigio	221004S 25	
		arancio	221004S 53	
		amaranto	221004S 65	
<i>Birdie lettura with touch dimmer</i>	A <sup>+</sup> , A	bianco	221004 10	373,00
		grigio	221004 25	
		arancio	221004 53	
		amaranto	221004 65	
<b>Spare parts:</b>				
<i>Lampshade Birdie</i>		bianco	221S00 10	66,00
		grigio	221S00 25	
		arancio	221S00 53	
		amaranto	221S00 65	

Colours: bianco, grigio,  
arancio, amaranto

Weight:  
net kg 4,30

Light bulbs not included  
→ specifications p. 186

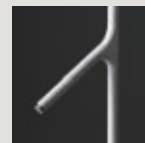
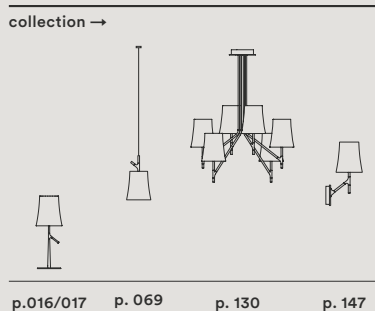
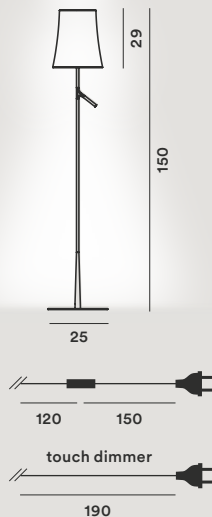

**Birdie LED**Ludovica + Roberto  
Palomba, 2011**LED**

	energy cl.	colours	code	€ vat excluded
<i>Birdie LED lettura</i>	A <sup>+</sup>	grafite	221004L-22	595,00
<i>with touch dimmer</i>		verde acqua	221004L-42	
		rame	221004L-80	

Polycarbonate, varnished  
steel and metalColours: grafite,  
verde acqua, rameWeight:  
net kg 4,30LED included  
Mid power 8,4 W 2700 K  
655 lm CRI>80

IP 20

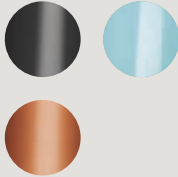

rame / grafite

verde acqua

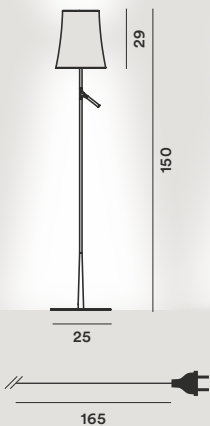

collection →

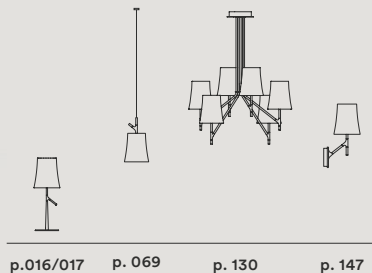

**Caboche**

Patricia Urquiola  
con Eliana Gerotto, 2005

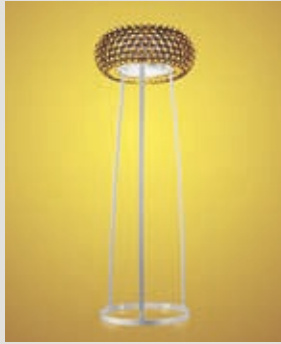

Polymethylmethacrylate,  
blown glass and white  
lacquered metal

*Caboche grande*  
Max t 1x230W R7s  
Dimmer included

*Caboche media*  
Max t 1x160W R7s  
Dimmer included



Please verify the  
compatibility of your bulb  
with the dimmer's wattage  
ranges, indicated on the  
dimmer itself, according to  
the kind of light source.



	energy cl.	colours	code	€ vat excluded
<i>Caboche grande</i>	A <sup>+</sup> , A, C	trasparente	138013 16	1.689,00
		giallo oro	138013 52	
<i>Caboche media</i>	A <sup>+</sup> , A, C	trasparente	138003 16	1.089,00
		giallo oro	138003 52	
<b>Spare parts:</b>				
<i>Kit 10 sphere Caboche</i>		trasparente	138KIT 10SF16	40,00
		giallo oro	138KIT 10SF52	
<i>Kit 20 prongs 4 spheres Caboche grande</i>			138KIT 20G4	38,00
<i>Kit 20 prongs 5 spheres Caboche grande</i>			138KIT 20G5	38,00
<i>Kit 3+3 prongs 4+5 spheres Caboche grande</i>			138KIT1-R2	21,00
<i>Kit 15 prongs 3 spheres Caboche media</i>			138KIT 15M3	30,00
<i>Kit 15 prongs 4 spheres Caboche media</i>			138KIT 15M4	30,00
<i>Kit 3+3 prongs 3-4 spheres Caboche media</i>			138KIT-R2	21,00
<i>Glass Caboche grande</i>			138V011/I	123,00
<i>Glass Caboche media</i>			138V01R1/I	81,00
<i>Halogen protection glass</i>			PIREX138/2S4I	21,00
<i>Halo. protection disk Caboche grande</i>			138V021/I	50,00
<i>Halo. protection disk Caboche media</i>			138V02/I	38,00

Colours: trasparente,  
giallo oro



Weight:  
*Caboche grande*  
net kg 23,90

*Caboche media*  
net kg 11,80

Light bulbs not included  
→ specifications p. 186

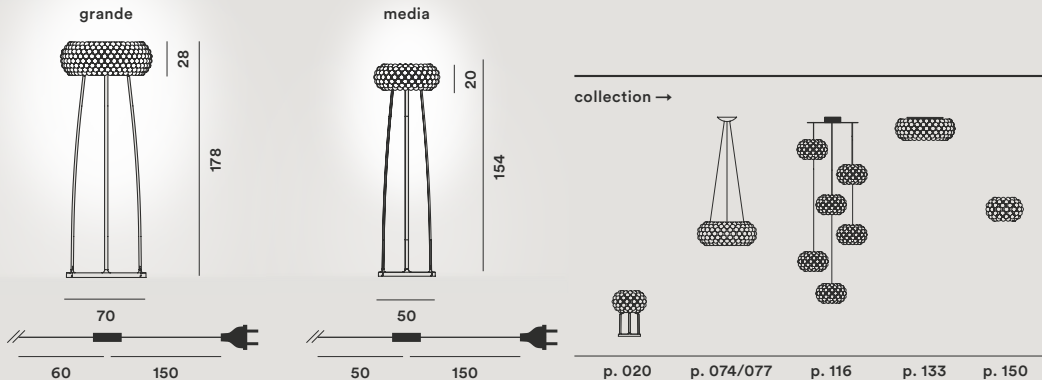



**Dolmen**

Ferruccio Laviani,  
1996/2017

LED



	energy cl.	colours	code	€ vat excluded
<i>Dolmen</i>	A <sup>+</sup>	alluminio	280003-25	1.371,00
		arancio	280003-14	1.517,00
		bronzo	280003-73	1.517,00

Varnished or anodised  
aluminium and PMMA

Colours: alluminio,  
arancione, bronzo

Weight:  
net kg 11,00

LED included  
Mid power 47W 2700 K  
6486 lm CRI>90  
Dimmer included

CE IP 20

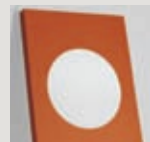
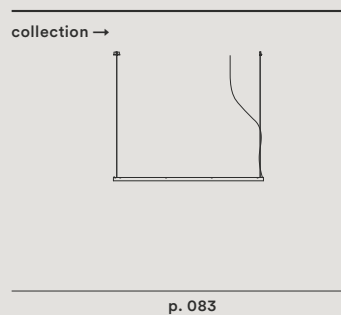
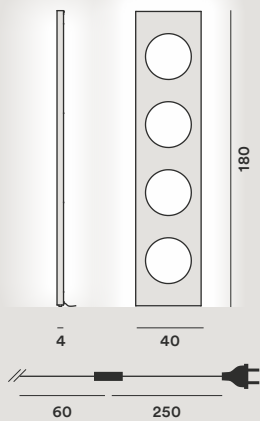

# 044 Terra, Floor

## Filo

Andrea Anastasio, 2017

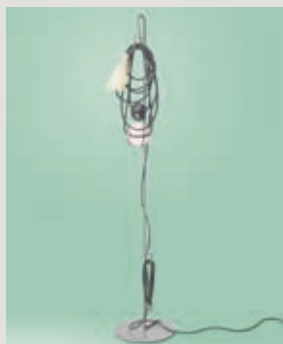

	energy cl.	colours	code	€ vat excluded
<i>Filo lettura</i>	A <sup>+</sup>	amethyst queen	289004-01	406,00
		eastern coral	289004-02	
		teodora	289004-04	
		emerald king	289004-08	

Porcelain, textile cable, blown glass and varnished metal

LED retrofit included  
4W G9 3000 K  
400 lm CRI>80



Colours:

*Amethyst Queen*

*Eastern Coral*

Weight:  
net kg 5,70

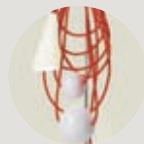
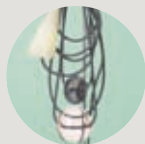

*Teodora*

*Emerald King*

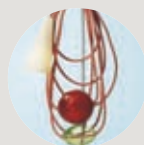
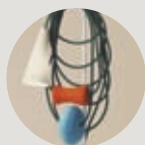

Tecnico — 2019

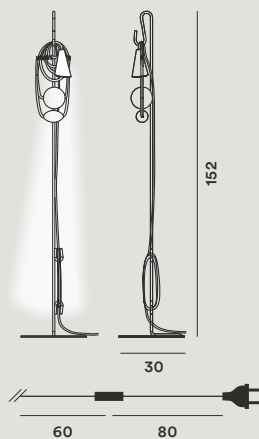

collection →

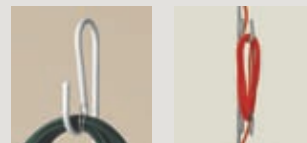
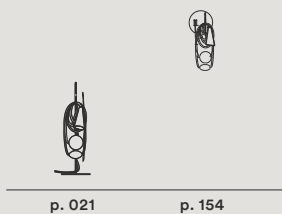

# Giga-Lite

Marc Sadler, 2004



Fibreglass fabric, carbonium thread and stainless steel

Extendable

Max 3x100W E27  
Dimmer included



Please verify the compatibility of your bulb with the dimmer's wattage ranges, indicated on the dimmer itself, according to the kind of light source.

CE IP 20

	energy cl.	colours	code	€ vat excluded
<b>Giga-Lite •</b>	A <sup>+</sup> , A	nero	139013 20	934,00
<b>Spare parts:</b>				
<b>Lampshade Giga-Lite</b>		nero	139S001 20	379,00

Colours: nero



Weight:  
net kg 9,80

Light bulbs not included  
→ specifications p. 186

•  
**On demand:**  
lead times to be checked with the sales department

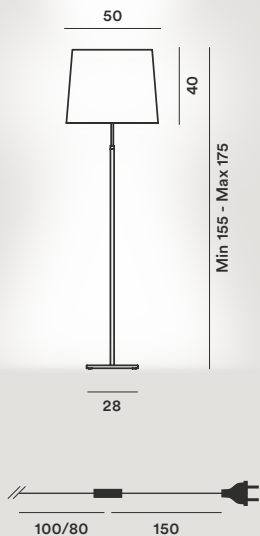

collection →

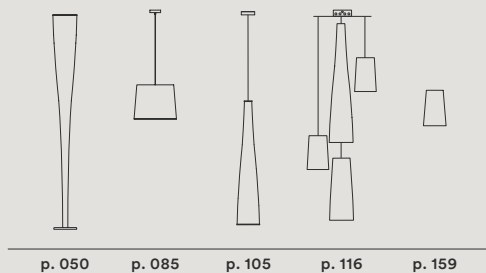

**Gregg**

Ludovica + Roberto  
Palomba, 2010



	energy cl.	colours	code	€ vat excluded
<i>Gregg grande</i> •	A <sup>+</sup> , A	bianco	168013A 10	858,00
<i>Gregg media</i> •	A <sup>+</sup> , A	bianco	168003A 10	704,00

**Spare parts:**

<i>Glass Gregg grande</i>	bianco	168S0031 10	334,00
<i>Glass Gregg media</i>	bianco	168S00 10	180,00

Blown acid-etched glass,  
lacquered polyurethane and  
metal

Colours: bianco



Weight:  
*Gregg grande*  
net kg 14,70

Light bulbs not included  
→ specifications p. 186

Max 1×205W E27  
Dimmer included

*Gregg media*  
net kg 11,70



Please verify the  
compatibility of your bulb  
with the dimmer's wattage  
ranges, indicated on the  
dimmer itself, according to  
the kind of light source.

•  
**On demand:**  
lead times to be  
checked with the  
sales department

☐ CE IP 20

Tecnico — 2019

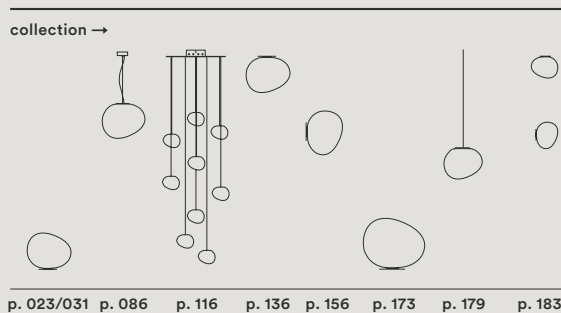
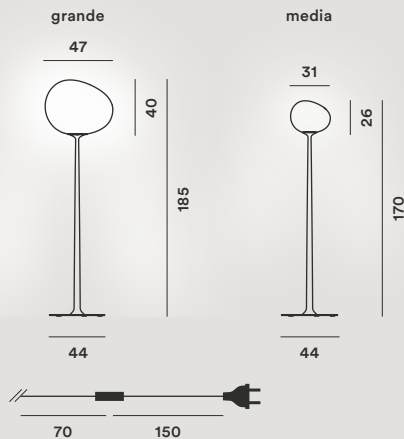

## Havana

Joseph Forakis, 1993



	energy cl.	colours	code	€ vat excluded
<i>Havana on/off</i>	A <sup>+</sup> , A	allum./bianco	040003 10	306,00
<i>Havana on/off</i>	A <sup>+</sup> , A	cromo/bianco	040003C 10	363,00
<i>Havana with dimmer</i>	A <sup>+</sup> , A	allum./bianco	040003 10 D	322,00
<i>Havana with dimmer</i>	A <sup>+</sup> , A	cromo/bianco	040003C 10 D	379,00
<b>Spare parts:</b>				
<i>Set lampshades Havana</i>		bianco	040S00 10	81,00

Injection moulded polyethylene and coated or chromed metal

Max 1x116W E27



Please verify the compatibility of your bulb with the dimmer's wattage ranges, indicated on the dimmer itself, according to the kind of light source.

☐ CE IP 20

Lampshade colours:  
bianco



Frame colours:  
alluminio, cromo



Weight:  
net kg 3,30

Light bulbs not included  
→ specifications p. 186

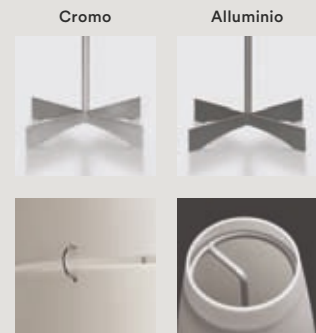
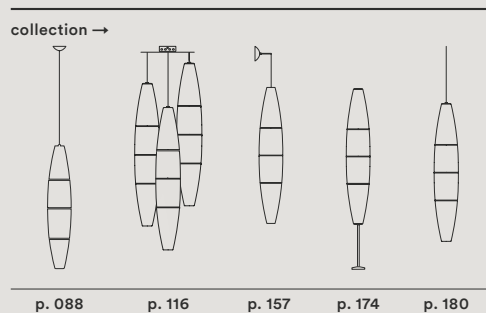
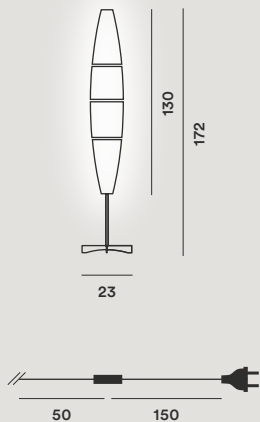

## Lumiere XXL

Rodolfo Dordoni, 2015



	energy cl.	colours	code	€ vat excluded
<i>Lumiere XXL</i>	A <sup>+</sup> , A, C	alluminio/bianco	191004A 11	1.020,00
		alluminio/grigio	191004A 24	
		cromo nero/bianco	191004C 11	
		cromo nero/grigio	191004C 24	
<b>Spare parts:</b>				
<i>Glass Lumiere XXL</i>		bianco	191S001 11	342,00
		grigio	191S001 24	

Blown glass and lacquered aluminium

Max 4x33W G9  
Dimmer included



Please verify the compatibility of your bulb with the dimmer's wattage ranges, indicated on the dimmer itself, according to the kind of light source.

CE IP 20

Glass colours:  
bianco, grigio freddo



Frame colours:  
alluminio, cromo nero



Weight:  
net kg 16,5

Light bulbs not included  
→ specifications p. 186

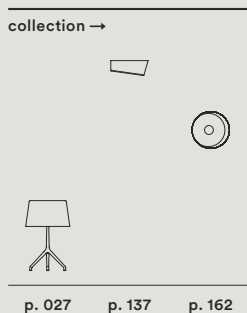
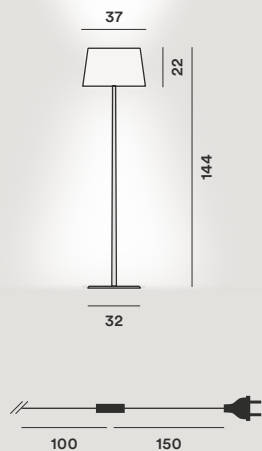

**Magneto**

Giulio Iacchetti, 2011

**LED**

	energy cl.	colours	code	€ vat excluded
<b>Magneto</b>	A <sup>+</sup>	bianco	202004R2 10	394,00
		nero	202004R2 20	

Coated steel, ABS and super magnet made of "rare earth"

Colours: bianco, nero

Weight:  
net kg 2,80



LED included  
Power LED 5W 2700 K  
475 lm CRI>80

☐ CE IP 20

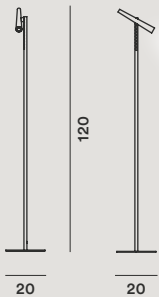

collection →



p. 029



**Mite**

Marc Sadler, 2000

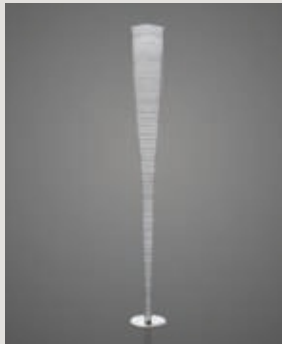

	energy cl.	colours	code	€ vat excluded
<b>Mite</b>	A <sup>+</sup> , A	giallo	111003R3 55	829,00
		nero	111003R3 20	
<b>Mite LED</b>	A	giallo	111003L 55	1.129,00
		nero	111003L 20	
<b>Spare parts:</b>				
<b>Lampshade Mite</b>		giallo	111S00 55	435,00
		nero	111S00 20	

Fibreglass fabric with Kevlar or carbonium thread, nickel-plated metal, steel and alluminium (LED) Kevlar® is a Dupont registered trademark

Colours: giallo, nero

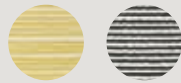

Weight:  
net kg 7,70

Light bulbs not included  
→ specifications p. 186

**Mite**  
Max 1x150W E27  
Dimmer included



Please verify the compatibility of your bulb with the dimmer's wattage ranges, indicated on the dimmer itself, according to the kind of light source.



Compasso  
D'Oro 2001

**Mite LED**  
LED included  
32,9W COB 3000 K  
3580 lm CRI>90  
Dimmer included



Tecnico — 2019

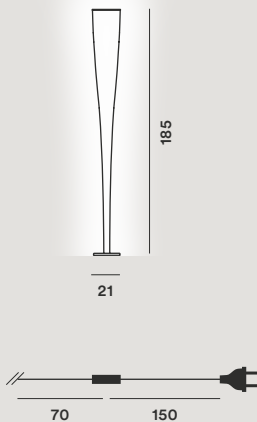

collection →

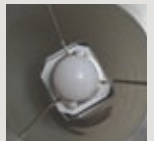
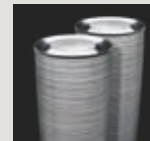
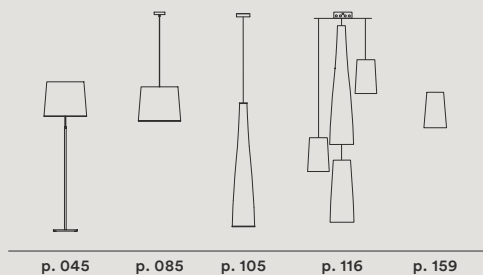



**Orbital**

Ferruccio Laviani, 1992



Silkscreen-printed glass and lacquered metal

Max 5x30W E14



	energy cl.	colours	code	€ vat excluded
<i>Orbital</i>	A <sup>+</sup> , A	bianco	036003 10	895,00
		colorato	036003	
<b>Spare parts:</b>				
<i>Glass set Orbital</i>		bianco	036S01 10	231,00
		colorato	036S01	
<i>Glass Orbital 1</i>		bianco	043S00/1 10	53,00
		rosso	043S00/1 63	
<i>Glass Orbital 2</i>		bianco	043S00/2 10	53,00
		blu	043S00/2 33	
<i>Glass Orbital 3</i>		bianco	043S00/3 10	53,00
<i>Glass Orbital 4</i>		bianco	043S00/4 10	53,00
		verde	043S00/4 40	
<i>Glass Orbital 5</i>		bianco	043S00/5 10	53,00
		arancio	043S00/5 52	

Colours: bianco, colorato

Weight:  
net kg 10,10

Light bulbs not included  
→ specifications p. 186

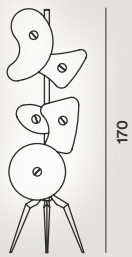

53

collection →



p. 148



**Tress**

Marc Sadler, 2008



Compound material on lacquered fibre base, coated metal and aluminium

**Tress grande**  
Max 1x250W R7s  
+ 100W E27 PAR 30  
Dimmer included  
Double switch

**Tress grande LED**  
LED included  
51,7W (39 COB + 6,3 Mid-power + 12,7 COB) 2700 K  
5254 lm CRI>90  
Dimmer included  
Double switch



**Tress media**  
Max 1x100W E27 PAR 30  
Dimmer included



	energy cl.	colours	code	€ vat excluded
<b>Tress grande</b>	A <sup>+</sup> , A	bianco	182003 10	1.252,00
		nero	182003 20	
		cremisi	182003 67	
		greige	182003 25	
		indaco	182003 87	
<b>Tress grande LED</b>	A	bianco	182003L 10	1.761,00
		nero	182003L 20	
		cremisi	182003L 67	
		greige	182003L 25	
		indaco	182003L 87	
<b>Tress media</b>	A <sup>+</sup> , A	bianco	182004 10	673,00
		nero	182004 20	
		cremisi	182004 67	
		greige	182004 25	
		indaco	182004 87	

**Spare parts:**

<b>Lampshade Tress media</b>	bianco	182S02 10	501,00
	nero	182S02 20	
	cremisi	182S02 67	
	greige	182S02 25	
	indaco	182S02 87	
<b>Halogen protection glass Tress grande</b>		PIREX138/2S4I	21,00

Colours: bianco, nero, cremisi, greige, indaco

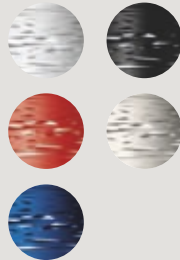

Weight:  
**Tress grande**  
net kg 8,50

**Tress media**  
net kg 3,90

**Tress grande LED**  
net kg 11,00

Light bulbs not included  
→ specifications p. 186



Please verify the compatibility of your bulb with the dimmer's wattage ranges, indicated on the dimmer itself, according to the kind of light source.

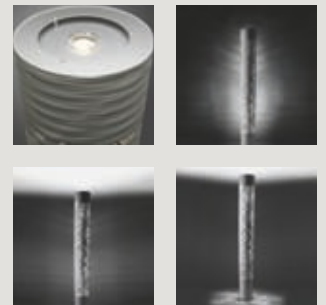
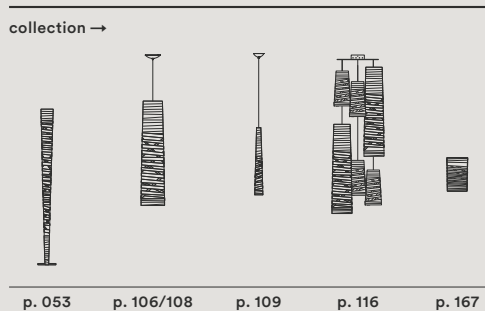
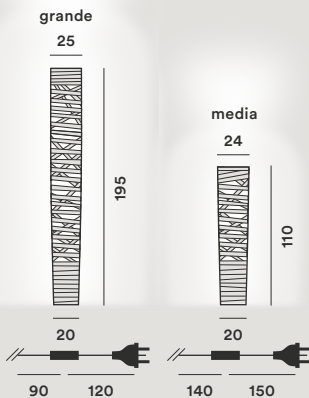

## Tress Stilo

Marc Sadler, 2011



	energy cl.	colours	code	€ vat excluded
<i>Tress Stilo</i>	A <sup>+</sup> , A	bianco	182043 10	795,00
		nero	182043 20	

### Spare parts:

<i>Lampshade Tress Stilo</i>	bianco	182S143 10	471,00
	nero	182S143 20	

Coated fibreglass-based composite material, lacquered metal and steel

Colours: bianco, nero

Weight:  
net kg 4,20

Light bulbs not included  
→ specifications p. 186



Max 1x100W E27 PAR  
Dimmer included



Please verify the compatibility of your bulb with the dimmer's wattage ranges, indicated on the dimmer itself, according to the kind of light source.

☐ CE IP 20

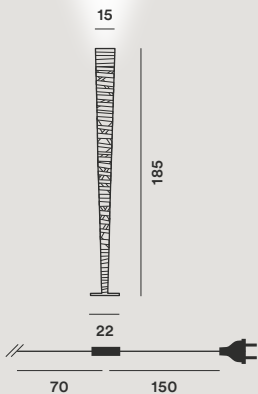

collection →

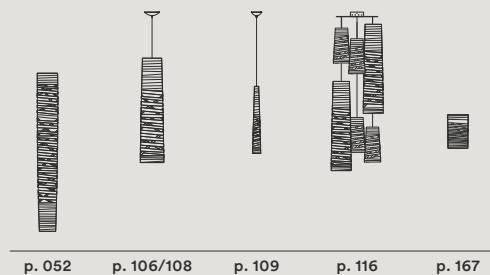

p. 052

p. 106/108

p. 109

p. 116

p. 167



**Tuareg**

Ferruccio Laviani, 2013

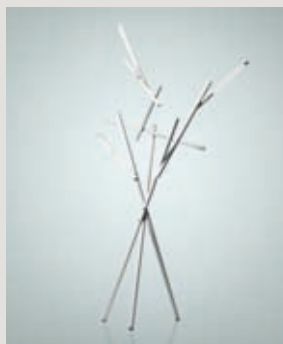

	energy cl.	colours	code	€ vat excluded
<i>Tuareg</i>	A	bianco	255003 10	2.726,00
		arancio	255003 53	2.726,00
		cromo nero	255003 78	3.069,00

Varnished aluminium and polycarbonate

LED included  
54W (3x18 Mid-power)  
3000 K 4050 lm CRI > 90  
3 separate switches and integrated touch dimmer orientable lights

☐ CE ◀ IP 20

Colours: bianco, arancio, cromo nero

Weight:  
net kg 9,20

LED and dimming  
→ specifications p. 186

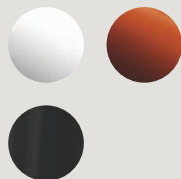

Tecnico — 2019

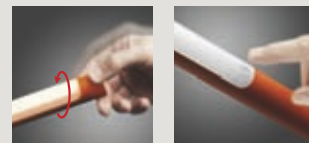
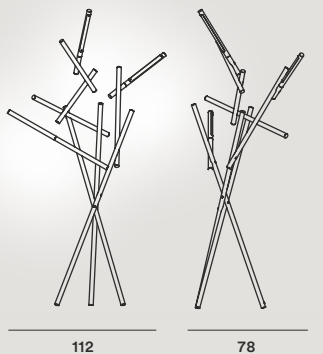

**Twice as Twiggy**

Marc Sadler, 2015

**LED**

	energy cl.	colours	code	€ vat excluded
<i>Twice as Twiggy</i>	A <sup>+</sup>	bianco	275013 10	5.054,00
		nero	275013 20	
		greige	275013 25	
		cremisi	275013 67	
		indaco	275013 87	

**Spare parts:**

<i>Lampshade Twice as Twiggy</i>	bianco	275S001 10	1.956,00
	nero	275S001 20	
	greige	275S001 25	
	cremisi	275S001 67	
	indaco	275S001 87	

Coated fibreglass-based composite material, PMMA, polycarbonate, coated metal and aluminium.

LED included  
81W (54+27 Mid-power)  
3000 K 8517 lm CRI>90  
Dimmer included

□ CE ⚡ IP 20

Colours: bianco, nero, cremisi, greige, indaco

Weight:  
net kg 57,60

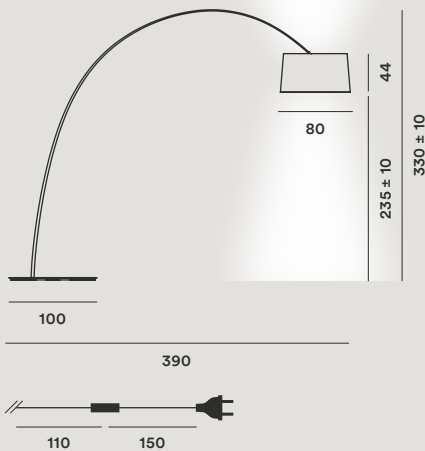
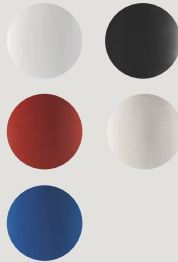

collection →

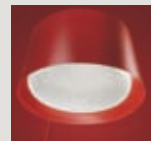

# Twiggy

Marc Sadler, 2006



Coated fibreglass-based composite material, PMMA, polycarbonate, coated metal and aluminium

Max 3x77W E27  
Dimmer included



Please verify the compatibility of your bulb with the dimmer's wattage ranges, indicated on the dimmer itself, according to the kind of light source.

CE IP 20

	energy cl.	colours	code	€ vat excluded
<b>Twiggy</b>	A+, A	bianco	159003 10	1.096,00
		nero	159003 20	
		greige	159003 25	
		cremisi	159003 67	
		indaco	159003 87	

**Accessories:**

<b>Additional stem set Twiggy (40 cm + 40 cm)</b>	bianco	159S031 10	170,00
	nero	159S031 20	
	greige	159S031 25	
	cremisi	159S031 67	
	indaco	159S031 87	

**Spare parts:**

<b>Lampshade Twiggy</b>	bianco	159S10 10	473,00
	nero	159S10 20	
	greige	159S10 25	
	cremisi	159S10 67	
	indaco	159S10 87	
<b>Lower diffusor disk</b>		159R05	33,00

Colours: bianco, nero, cremisi, greige, indaco

Weight: net kg 16,60

Light bulbs not included → specifications p. 186

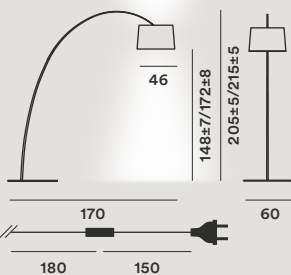
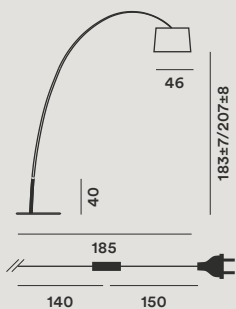
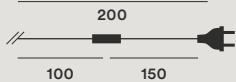
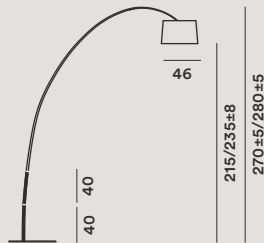
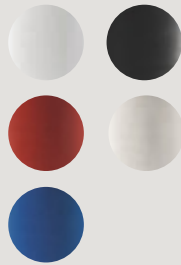

collection →



## Twiggy LED Twiggy MyLight

Marc Sadler, 2006



Coated fibreglass-based composite material, PMMA, polycarbonate, coated metal and aluminium

LED included  
33 W (25+8 Mid-power) 3000 K  
2920 lm CRI>90

*Twiggy MyLight*  
Dimmable via Bluetooth with  
Casambi »

☐ CE IP 20



	energy cl.	colours	code	€ vat excluded
<i>Twiggy MyLight</i>	A <sup>+</sup>	bianco	159003L 10	1.533,00
		nero	159003L 20	
		greige	159003L 25	
		cremisi	159003L 67	
		indaco	159003L 87	
<i>Twiggy LED MyLight</i>	A <sup>+</sup>	bianco	159003ML-10	1.567,00
		nero	159003ML-20	
		greige	159003ML-25	
		cremisi	159003ML-67	
		indaco	159003ML-87	

### Accessories:

				€ vat excluded
<i>Additional stem set Twiggy</i> (40 cm + 40 cm)	bianco	159S031 10	170,00	
	nero	159S031 20		
	greige	159S031 25		
	cremisi	159S031 67		
	indaco	159S031 87		

### Spare parts:

				€ vat excluded
<i>Lampshade Twiggy</i>	bianco	159S10 10	473,00	
	nero	159S10 20		
	greige	159S10 25		
	cremisi	159S10 67		
	indaco	159S10 87		

Colours: bianco, nero,  
cremisi, greige, indaco

Weight:  
net kg 17,10

MyLight collection  
→ specifiche p. 186

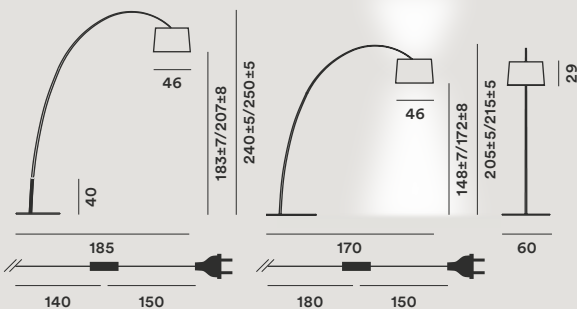
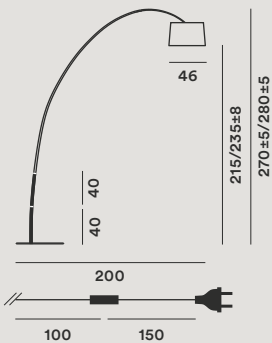
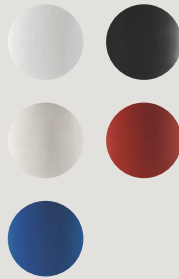

collection →

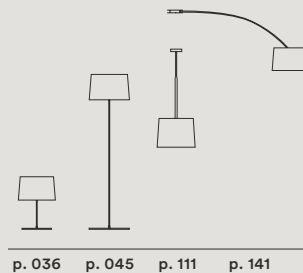

## Twiggy Lettura

Marc Sadler, 2008



	energy cl.	colours	code	€ vat excluded
<i>Twiggy lettura</i> •	A <sup>+</sup> , A	bianco	159004 10	913,00
		nero	159004 20	
<b>Spare parts:</b>				
<i>Lampshade Twiggy</i>		bianco	159S10 10	473,00
		nero	159S10 20	

Coated fibreglass-based composite material, PMMA, polycarbonate and coated metal

Colours: bianco, nero

Weight:  
net kg 11,30

Light bulbs not included  
→ specifications p. 186



Max 3x100W E27  
Dimmer included



Please verify the compatibility of your bulb with the dimmer's wattage ranges, indicated on the dimmer itself, according to the kind of light source.

• **On demand:**  
lead times to be checked with the sales department

☐ CE IP 20

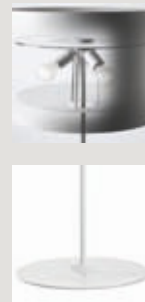
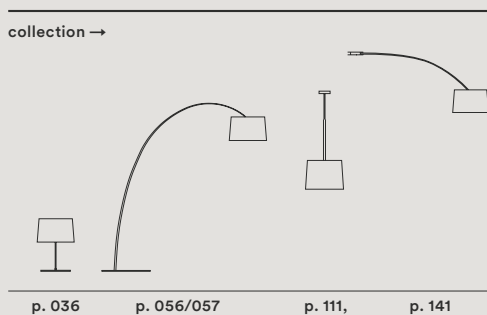
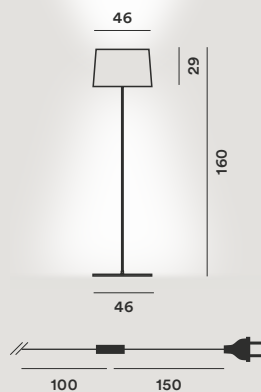







Sospensione, *Suspension*

- |      |                   |     |                        |
|------|-------------------|-----|------------------------|
| 062  | <b>Allegretto</b> | 091 | <b>Lightweight</b>     |
| 063  | <b>Allegro</b>    | 092 | <b>Maki</b>            |
| 0664 | <b>Aplomb</b>     | 093 | <b>O-Space</b>         |
| 067  | <b>Arumi</b>      | 094 | <b>Plass</b>           |
| 068  | <b>Behive</b>     | 098 | <b>Plena</b>           |
| 070  | <b>Big Bang</b>   | 096 | <b>Rituals</b>         |
| 069  | <b>Birdie</b>     | 099 | <b>Satellite</b>       |
| 072  | <b>Buds</b>       | 100 | <b>Spokes</b>          |
| 074  | <b>Caboche</b>    | 103 | <b>Supernova</b>       |
| 082  | <b>Caiigo</b>     | 104 | <b>Tartan</b>          |
| 078  | <b>Chouchin</b>   | 105 | <b>Tite</b>            |
| 083  | <b>Dolmen</b>     | 106 | <b>Tress</b>           |
| 084  | <b>Gem</b>        | 109 | <b>Tress Stilo</b>     |
| 085  | <b>Giga-Lite</b>  | 110 | <b>Troag</b>           |
| 086  | <b>Gregg</b>      | 113 | <b>Twice as Twiggy</b> |
| 088  | <b>Havana</b>     | 111 | <b>Twiggy</b>          |
| 089  | <b>Le Soleil</b>  | 114 | <b>Uto</b>             |

**Allegretto**

Atelier Oi, 2009

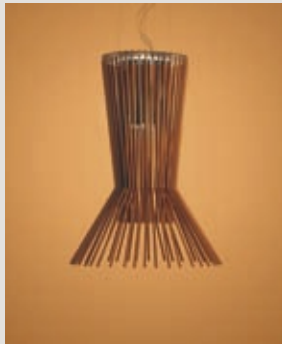

Varnished aluminium and metal

Max 2x100W E27 PAR 30



	energy cl.	colours	code	€ vat excluded
<i>Allegretto Ritmico</i>	A <sup>+</sup> , A	grafite	1690171 20	1.521,00
<i>Allegretto Vivace</i>	A <sup>+</sup> , A	rame	1690172 80	1.821,00
<i>Allegretto Assai</i>	A <sup>+</sup> , A	oro	1690173 71	2.088,00
<i>Allegretto Ritmico h. 10 m</i> •	A <sup>+</sup> , A	grafite	1690171/10-20	1.686,00
<i>Allegretto Vivace h. 10 m</i> •	A <sup>+</sup> , A	rame	1690172/10-80	1.986,00
<i>Allegretto Assai h. 10 m</i> •	A <sup>+</sup> , A	oro	1690173/10-71	2.253,00

**Accessories:**

<i>Decentralization kit</i> for steel cables	KIT DEC B	28,00
for steel cables + canopy	KIT DEC F	49,00

Colours:  
Assai oro,  
Vivace rame,  
Ritmico grafite

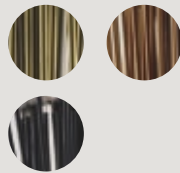

Weight:  
*Allegretto Ritmico*  
net kg 5,10

*Allegretto Vivace*  
net kg 9,10

*Allegretto Assai*  
net kg 11,30

•  
**On demand:**  
lead times to be  
checked with the  
sales department

Light bulbs not included  
→ specifications p. 186

Decentralization  
→ specifications p. 124

Ritmico

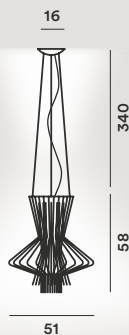

Vivace

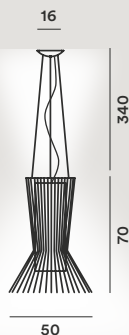

Assai

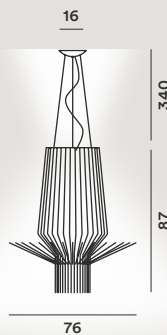

**Allegro**

Atelier Oi, 2007

LED



Varnished aluminium and metal

*Allegro LED included*  
51W (39,4 COB + 11 Multichip)  
3000 K 5684 lm CRI>90  
Dimmable  
Possible configurations:  
On-Off/Push/DALI

*Allegro*  
Max 1x230W R7s +  
1x100W E27 PAR 30

Double switch

⊕ CE IP 20

	energy cl.	colours	code	€ vat excluded
<i>Allegro Ritmico LED</i>	A <sup>+</sup>	grafite	1690071L 20	2.948,00
<i>Allegro Vivace LED</i>		rame	1690072L 80	3.805,00
<i>Allegro Assai LED</i>		oro	1690073L 71	5.571,00
<i>Allegro Ritmico</i>	A <sup>+</sup> , A, C	grafite	1690071 20	2.606,00
<i>Allegro Vivace</i>		rame	1690072 80	3.463,00
<i>Allegro Assai</i>		oro	1690073 71	5.229,00
<i>Allegro Ritmico LED h. 10 m • A<sup>+</sup></i>		grafite	1690071L/1020	3.101,00
<i>Allegro Vivace LED h. 10 m •</i>		rame	1690072L/1080	3.958,00
<i>Allegro Assai LED h. 10 m •</i>		oro	1690073L/1071	5.724,00
<i>Allegro Ritmico h. 10 m • A<sup>+</sup>, A, C</i>		grafite	1690071/10-20	2.733,00
<i>Allegro Vivace h. 10 m •</i>		rame	1690072/10-80	3.590,00
<i>Allegro Assai h. 10 m •</i>		oro	1690073/10-71	5.356,00

**Spare parts:**

<i>Halogen protection glass</i>	PIREX138/4/1	27,00
---------------------------------	--------------	-------

**Accessories:**

<i>Decentralization kit for steel cables</i>	KIT DEC B	28,00
<i>for steel cables + canopy</i>	KIT DEC F	49,00

**Colours:**

Assai oro,  
Vivace rame,  
Ritmico grafite

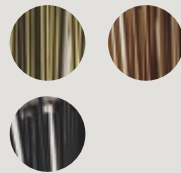
**Weight:**

*Allegro Ritmico*  
net kg 15,00

*Allegro Vivace*  
net kg 19,30

*Allegro Assai*  
net kg 36,00

Light bulbs not included  
→ specifications p. 186

Decentralization  
→ specifications p. 124

LED and dimming  
→ specifications p. 185

• **On demand:**  
lead times to be  
checked with the sales  
department

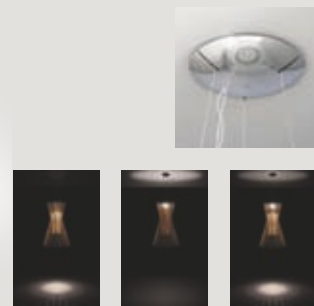
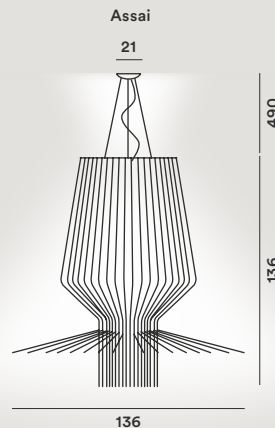
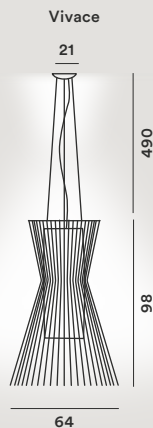
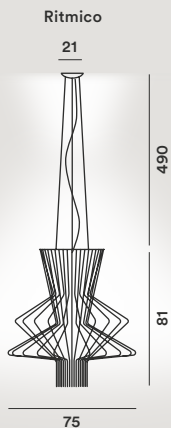

## Aplomb

Lucidi e Pevere, 2010



Hand pouring concrete and aluminium

*Aplomb G9*  
Max 1x60W

*Aplomb GU10*  
Max 1x8W PAR 16



	energy cl.	colours	code	€ vat excluded
<i>Aplomb G9</i>	A <sup>+</sup> , A, C	bianco	195007R1-10	311,00
		grigio	195007R1-25	
		marrone	195007R1-52	
<i>Aplomb GU10</i>	A <sup>+</sup> , A	bianco	195007L/3-10	311,00
		grigio	195007L/3-25	
		marrone	195007L/3-52	
		verde	195007L/3-43	
		giallo	195007L/3-56	
		rosso	195007L/3-64	
<i>Aplomb G9 h. 10 m •</i>	A <sup>+</sup> , A, C	bianco	195007R1/1010	357,00
		grigio	195007R1/1025	
		marrone	195007R1/1052	
<i>Aplomb GU10 h. 10 m •</i>	A <sup>+</sup> , A	bianco	195007L/10-10	357,00
		grigio	195007L/10-25	
		marrone	195007L/10-52	
		verde	195007L/10-43	
		giallo	195007L/10-56	
		rosso	195007L/10-64	
<b>Accessories:</b>				
<i>Decentralization kit</i> for power cable			KIT DEC C	33,00
canopy for electrical dec.			KIT DEC M	87,00

Colours: bianco, grigio cemento, marrone, verde oliva, giallo sabbia, rosso mattone



Weight:  
net kg 1,90

**On demand:**  
lead times to be checked with the sales department

Light bulbs not included  
→ specifications p. 186

Multiple canopy  
→ specifications p. 116

Decentralization  
→ specifications p. 124

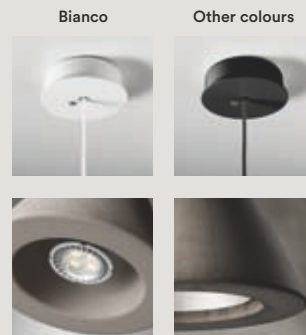
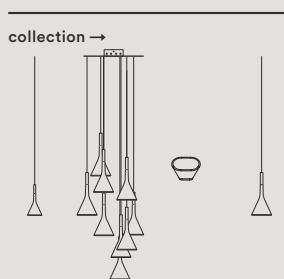
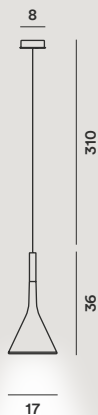

## Aplomb Large

Lucidi e Pevere, 2016

LED



Hand pouring concrete,  
aluminium and  
polycarbonate

LED Included  
11,7W Multichip mid power  
2700 K 1279 lm CRI>90  
Dimmable LED version  
Possible configurations:  
On-Off/Push/DALI

⊕ CE IP 20

	energy cl.	colours	code	€ vat excluded
<i>Aplomb large</i>	A <sup>+</sup>	bianco	195017 10	511,00
		grigio	195017 25	
		marrone	195017 52	
<i>Aplomb large dimmable</i>	A <sup>+</sup>	bianco	195017D 10	558,00
		grigio	195017D 25	
		marrone	195017D 52	
<i>Aplomb large h. 10 m •</i>	A <sup>+</sup>	bianco	195017/10-10	539,00
		grigio	195017/10-25	
		marrone	195017/10-52	
<i>Aplomb large dimmable h. 10 m •</i>	A <sup>+</sup>	bianco	195017D/10-10	586,00
		grigio	195017D/10-25	
		marrone	195017D/10-52	

### Accessories:

<i>Decentralization kit</i> for power cable	KIT DEC C	33,00
---	-----------	-------

Colours: bianco,  
grigio cemento,  
marrone



Weight:  
net kg 4,00

LED and dimming  
→ specifications p. 185

• On demand:  
lead times to be  
checked with the  
sales department

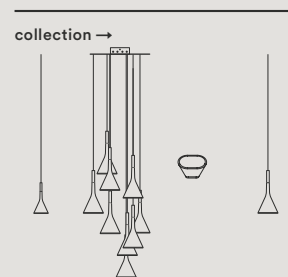
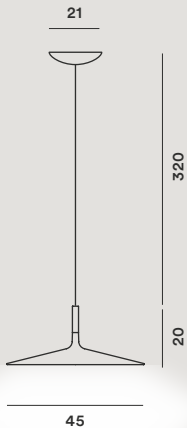

p. 066 p. 116 p. 144 p. 178

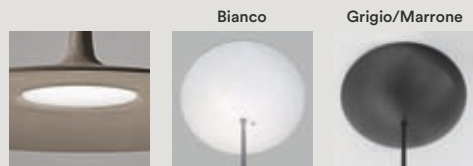

**Aplomb mini**

Lucidi e Pevere, 2015



	energy cl.	colours	code	€ vat excluded
<i>Aplomb mini</i>	A+, A	bianco	195027R1-10	225,00
		grigio	195027R1-25	
		marrone	195027R1-52	
<i>Aplomb mini h. 10 m</i> •	A+, A	bianco	195027R1/1010	271,00
		grigio	195027R1/1025	
		marrone	195027R1/1052	
<b>Accessories:</b>				
<i>Decentralization kit</i> for power cable			KIT DEC C	33,00
canopy for electrical dec.			KIT DEC M	87,00

Hand pouring concrete and aluminium

Max 1x8W PAR 16



Colours: bianco, grigio cemento, marrone



Weight:  
net kg 0,70

•  
**On demand:**  
lead times to be  
checked with the  
sales department

Light bulbs not included  
→ specifications p. 186

Multiple canopy  
→ specifications p. 116

Decentralization  
→ specifications p. 124



11,5



p. 116 p. 144 p. 178

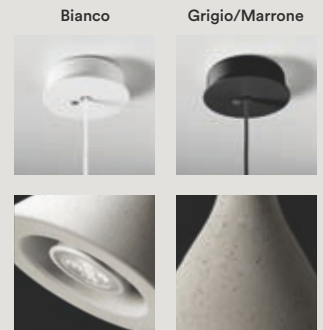



## Arumi

Lucidi e Pevere, 2017

LED



Die cast polished aluminium and PMMA

LED included  
COB 10W 2700 K  
850 lm CRI>80  
Dimmable with TRIAC technology

⊕ CE IP 20

	energy cl.	colours	code	€ vat excluded
<i>Arumi</i>	A	alluminio	282027-77	285,00
<i>Arumi h. 10 m •</i>	A	alluminio	282027/10-77	360,00

**Accessories:**

<i>Decentralization kit</i> for power cable		KIT DEC C	33,00
canopy for electrical dec.		KIT DEC M	87,00

Colours: alluminio



Weight:  
net kg 1,00

LED and dimming  
→ specifications  
p. 185

- **On demand:**  
lead times to be checked with the sales department

The designers and the company chose to emphasize the material and the manual finishing of the lamp's external surface, leaving it rough and with no protective coating, in order to produce a chromatic alteration over time. On the other hand, it is possible to remove finger prints or dirt, cleaning only the external rough surface with water and a mild detergent with neutral-physiological pH factor.



## Behive

Werner Aisslinger, 2012



	energy cl.	colours	code	€ vat excluded
<i>Behive</i>	A <sup>+</sup> , A	bianco	203007 10	463,00
<i>Behive h. 10 m •</i>	A <sup>+</sup> , A	bianco	203007/10-10	537,00

### Spare parts:

<i>Lampshade Behive</i>	bianco	203S007 10	215,00
<i>Protection glass</i>		203V02/1	50,00

### Accessories:

<i>Decentralization kit</i> for steel cables		KIT DEC B	28,00
	for steel cables + canopy	KIT DEC F	49,00
	canopy for electrical dec.	KIT DEC M	87,00

Batch-dyed ABS and polycarbonate

Max 1×150W E27



Colours: bianco



Weight:  
net kg 3,10

•

**On demand:**  
lead times to be  
checked with the  
sales department

Light bulbs not included  
→ specifications p. 186

Decentralization  
→ specifications p. 124

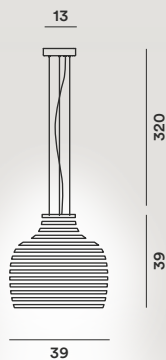

collection →

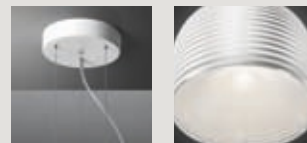

## Birdie

Ludovica + Roberto  
Palomba, 2013



Polycarbonate  
and metallized steel

*Birdie grande*  
Max 1x150W E27

*Birdie piccola*  
Max 1x70W E27

⊕ CE IP 20

	energy cl.	colours	code	€ vat excluded
<i>Birdie grande</i>	A+, A	bianco	221017 10	208,00
		grigio	221017 25	
		arancio	221017 53	
		amaranto	221017 65	
<i>Birdie piccola</i>	A+, A	bianco	221027 10	179,00
		grigio	221027 25	
		arancio	221027 53	
		amaranto	221027 65	
<i>Birdie grande h. 10 m •</i>	A+, A	bianco	221017/10-10	263,00
		grigio	221017/10-25	
		arancio	221017/10-53	
		amaranto	221017/10-65	
<i>Birdie piccola h. 10 m •</i>	A+, A	bianco	221027/10-10	234,00
		grigio	221027/10-25	
		arancio	221027/10-53	
		amaranto	221027/10-65	
<b>Accessories:</b>				
<i>Decentralization kit</i> for power cable			KIT DEC C	33,00
canopy for electrical dec.			KIT DEC M	87,00

Colours: bianco, grigio,  
arancio, amaranto



Weight:  
*Birdie grande*  
net kg 1,30

*Birdie piccola*  
net kg 1,00

•  
**On demand:**  
lead times to be  
checked with the  
sales department

Light bulbs not included  
→ specifications p. 186

Multiple canopy  
→ specifications p. 116

Decentralization  
→ specifications p. 124

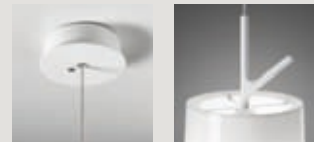
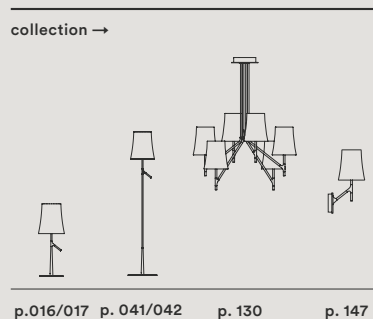
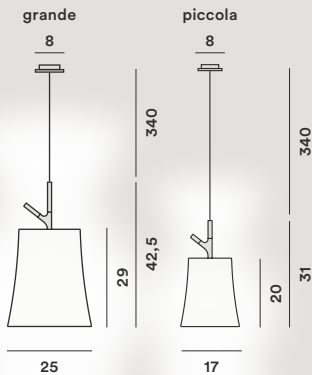

## Big Bang

Enrico Franzolini con  
Vicente Garcia Jimenez, 2005



Methacrylate and coated  
aluminium

*Big Bang LED* included  
37W Mid power 3000 K  
3260 lm CRI>90  
Dimmable LED version  
Possible configurations:  
On-Off/Push/DALI

*Big Bang*  
Max 1x160W R7s



	energy cl.	colours	code	€ vat excluded
<i>Big Bang LED</i>	A <sup>+</sup>	bianco	151007L 10	1.128,00
		rosso	151007L 63	1.248,00
<i>Big Bang LED dimmable</i>	A <sup>+</sup>	bianco	151007LD 10	1.215,00
		rosso	151007LD 63	1.335,00
<i>Big Bang</i>	A <sup>+</sup> , A, C	bianco	151007 10	675,00
		rosso	151007 63	795,00
<i>Big Bang LED h. 10 m •</i>	A <sup>+</sup>	bianco	151007L/10-10	1.230,00
		rosso	151007L/10-63	1.350,00
<i>Big Bang LED dimmable h. 10 m •</i>	A <sup>+</sup>	bianco	151007LD10-10	1.317,00
		rosso	151007LD10-63	1.437,00
<i>Big Bang h. 10 m •</i>	A <sup>+</sup> , A, C	bianco	151007 10SP10	777,00
		rosso	151007 63SP10	897,00

### Spare parts:

<i>Set lampshades Big Bang</i>	bianco	151S00 10	264,00
	rosso	151S00 63	384,00
<i>Halogen protection glass</i>		PIREX180-50/I	26,00

### Accessories:

<i>Decentralization kit</i>	for steel cables	KIT DEC B	28,00
	for steel cables + canopy	KIT DEC F	49,00
	canopy for electrical dec.	KIT DEC M	87,00

Colours: bianco, rosso



Weight:  
*Big Bang LED*  
net kg 7,40

*Big Bang*  
net kg 5,40

•

On demand:  
lead times to be  
checked with the  
sales department

Light bulbs not included  
→ specifications p. 186

Decentralization  
→ specifications p. 124

LED and dimming  
→ specifications p. 185

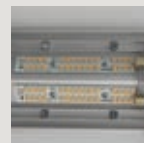
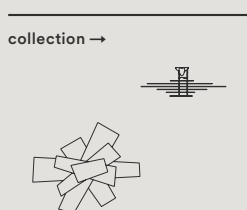
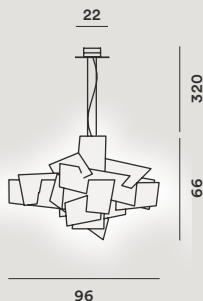

**Big Bang L - XL**

Enrico Franzolini con  
Vicente Garcia Jimenez,  
2005-2016



Methacrylate and coated  
aluminium

**Big Bang L**

LED included

58W Mid power 3000 K

6084 lm CRI>90

Dimmable

Possible configurations:

On-Off/Push/DALI

**Big Bang XL**

LED included

87W Mid power 3000 K

9126 lm CRI>90

Dimmable

Possible configurations:

On-Off/Push/DALI

⊕ CE IP 20



	energy cl.	colours	code	€ vat excluded
<b>Big Bang L</b>	A <sup>+</sup>	bianco	151017 10	2.320,00
		rosso	151017 63	2.460,00
<b>Big Bang XL</b>	A <sup>+</sup>	bianco	1510072L 10	3.717,00
		rosso	1510072L 63	4.282,00
<b>Big Bang L h. 10 m •</b>	A <sup>+</sup>	bianco	151017/10-10	2.402,00
		rosso	151017/10-63	2.542,00
<b>Big Bang XL h. 10 m •</b>	A <sup>+</sup>	bianco	1510072L/1010	3.799,00
		rosso	1510072L/1063	4.364,00

**Spare parts:**

<b>Set diffusori Big Bang L</b>	bianco	151S001 10	967,00
	rosso	151S001 63	1.107,00
<b>Set diffusori Big Bang XL</b>	bianco	151S002 10	1.889,00
	rosso	151S002 63	2.454,00

**Accessories:**

<b>Decentralization kit</b> for steel cables	KIT DEC B	28,00
--	-----------	-------

Colours: bianco, rosso



Weight:

**Big Bang L**

net kg 18,00

**Big Bang XL**

net kg 33,00

Light bulbs not included

→ specifications p. 186

Decentralization

→ specifications p. 124

LED and dimming

→ specifications p. 185



**On demand:**

lead times to be  
checked with the  
sales department

Big Bang L

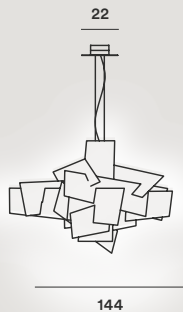

Big Bang XL

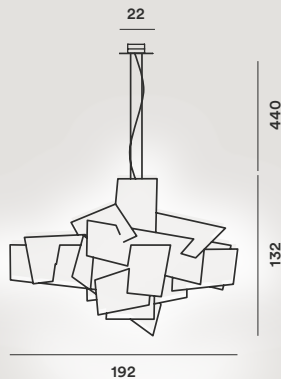

collection →

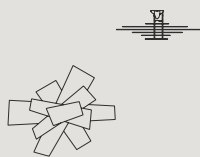

p. 146

p. 129



## 072 Sospensione, Suspension

### Buds

Rodolfo Dordoni, 2016



Blown glass

#### Buds 1-2-3

LED retrofit included  
21W E27 2700 K  
2500 lm CRI>80  
Dimmable with  
TRIAC technology

#### Buds 1-2-3 LED included

24W COB 2700 K  
2581 lm CRI>90  
Dimmable version  
Possible configurations:  
On-Off/Push/DALI

⊕ CE IP 20

	energy cl.	colours	code	€ vat excluded
<b>Buds 1</b>	A <sup>+</sup>	bianco caldo	278071E-12	505,00
<b>Buds 2</b>		bianco caldo	278072E-12	535,00
		grigio	278072E-24	
<b>Buds 3</b>		bianco caldo	278073E-12	477,00
		verde	278073E-40	
<b>Buds 1 LED •</b>	A <sup>+</sup>	bianco caldo	278071L 12	613,00
<b>Buds 2 LED •</b>		bianco caldo	278072L 12	643,00
		grigio	278072L 24	
<b>Buds 3 LED •</b>		bianco caldo	278073L 12	585,00
		verde	278073L 40	
<b>Buds 1 LED dimmable •</b>	A <sup>+</sup>	bianco caldo	278071LD 12	669,00
<b>Buds 2 LED dimmable •</b>		bianco caldo	278072LD 12	699,00
		grigio	278072LD 24	
<b>Buds 3 LED dimmable •</b>		bianco caldo	278073LD 12	641,00
		verde	278073LD 40	

#### Colours:

**Buds 1** bianco caldo  
**Buds 2** bianco caldo,  
grigio.  
**Buds 3** bianco caldo,  
verde bambù

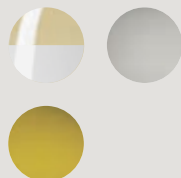

#### Weight:

**Buds 1**  
net kg 3,60

**Buds 2**  
net kg 4,90

**Buds 3**  
net kg 2,90

**Buds 1 LED**  
net kg 4,20

**Buds 2 LED**  
net kg 5,50

**Buds 3 LED**  
net kg 3,50

#### LED and dimming

→ specifications p. 185

Tecnico — 2019

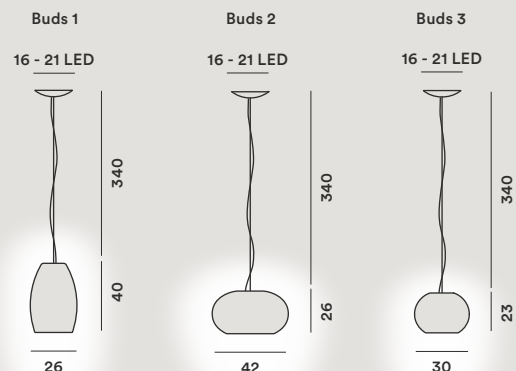

collection →



p. 019

	energy cl.	colours	code	€ vat excluded
<b>Buds 1 h. 10 m •</b>	A <sup>+</sup>	bianco caldo	278071E/10-12	549,00
<b>Buds 2 h. 10 m •</b>		bianco caldo	278072E/10-12	579,00
		grigio	278072E/10-24	
<b>Buds 3 h. 10 m •</b>		bianco caldo	278073E/10-12	521,00
		verde	278073E/10-40	
<b>Buds 1 LED h. 10 m •</b>	A <sup>+</sup>	bianco caldo	278071L/10-12	655,00
<b>Buds 2 LED h. 10 m •</b>		bianco caldo	278072L/10-12	685,00
		grigio	278072L/10-24	
<b>Buds 3 LED h. 10 m •</b>		bianco caldo	278073L/10-12	627,00
		verde	278073L/10-40	
<b>Buds 1 LED dimm. h. 10 m •</b>	A <sup>+</sup>	bianco caldo	278071LD/1012	711,00
<b>Buds 2 LED dimm. h. 10 m •</b>		bianco caldo	278072LD/1012	741,00
		grigio	278072LD/1024	
<b>Buds 3 LED dimm. h. 10 m •</b>		bianco caldo	278073LD/1012	683,00
		verde	278073LD/1040	

**Spare parts:**

<b>Glass Buds 1</b>	bianco caldo	278S001 12	356,00
<b>Glass Buds 2</b>	bianco caldo	278S002 12	386,00
	grigio	278S002 24	
<b>Glass Buds 3</b>	bianco caldo	278S003 12	328,00
	verde	278S003 40	
<b>Glass Buds 1 LED</b>	bianco caldo	278S0071 12	356,00
<b>Glass Buds 2 LED</b>	bianco caldo	278S0072 12	386,00
	grigio	278S0072 24	
<b>Glass Buds 3 LED</b>	bianco caldo	278S0073 12	328,00
	verde	278S0073 24	

•

**On demand:**  
lead times to be  
checked with the sales  
department



**Caboche grande**

Patricia Urquiola  
con Eliana Gerotto, 2005



PMMA, blown glass,  
chromed metal and  
aluminium (LED)

*Caboche grande*  
LED included  
47W (37 + 10 Mid-power)  
3000 K 4330 lm CRI>90  
Dimmable version  
Possible configurations:  
On-Off/Push/DALI

*Caboche grande*  
Max 1x230W R7s



	energy cl.	colours	code	€ vat excluded
<i>Caboche grande LED</i>	A <sup>+</sup>	trasparente	138017L 16	2.177,00
		giallo oro	138017L 52	
<i>Caboche grande LED dimmable</i>	A <sup>+</sup>	trasparente	138017LD 16	2.262,00
		giallo oro	138017LD 52	
<i>Caboche grande</i>	A <sup>+</sup> , A, C	trasparente	138017 16	1.549,00
		giallo oro	138017 52	
<i>Caboche grande LED h. 10 m •</i>	A <sup>+</sup>	trasparente	138017L/10-16	2.416,00
		giallo oro	138017L/10-52	
<i>Caboche grande LED dimmable h. 10 m •</i>	A <sup>+</sup>	trasparente	138017LD/1016	2.501,00
		giallo oro	138017LD/1052	
<i>Caboche grande h. 10 m •</i>	A <sup>+</sup> , A, C	trasparente	138017/10-16	1.788,00
		giallo oro	138017/10-52	

**Spare parts:**

<i>Kit 10 spheres Caboche</i>	trasparente	138KIT 10SF16	40,00
	giallo oro	138KIT 10SF52	
<i>Kit 20 prongs 4 spheres Caboche</i>		138KIT 20G4	38,00
<i>Kit 20 prongs 5 spheres Caboche</i>		138KIT 20G5	38,00
<i>Kit 3+3 prongs 4-5 spheres Caboche</i>		138KIT1-R2	21,00
<i>Inner glass Caboche LED</i>		138V0118/I	121,00
<i>Inner glass Caboche halogen</i>		138V011/I	123,00
<i>Halogen protection glass</i>		PIREX138/2S4I	21,00
<i>Halogen protection disk Caboche</i>		138V021/I	50,00

**Accessories:**

<i>Decentralization kit for steel cables</i>		KIT DEC B	28,00
	for steel cables + canopy	KIT DEC F	49,00
	canopy for electrical dec.	KIT DEC M	87,00

Colours: trasparente,  
giallo oro



Weight:  
*Caboche grande LED*  
net kg 17,00

*Caboche grande*  
net kg 19,60

Light bulbs not included  
→ specifications p. 186

Decentralization  
→ specifications p. 124

LED and dimming  
→ specifications p. 185

•  
**On demand:**  
lead times to be  
checked with the  
sales department

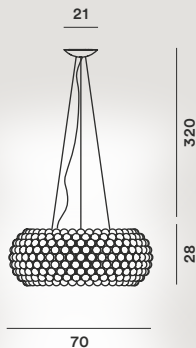

collection →

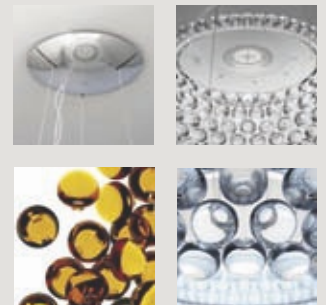
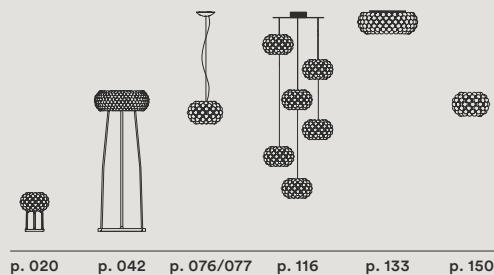



## Caboche media

Patricia Urquiola  
con Eliana Gerotto, 2005



PMMA, blown glass,  
chromed metal and  
aluminium (LED)

*Caboche media*  
LED included  
35W (28 + 7Mid power)  
3000 K 3062 lm CRI > 90  
Dimmable version  
Possible configurations:  
On-Off/Push/DALI

*Caboche media*  
Max 1x160W R7s

⊕ CE IP 20



	energy cl.	colours	code	€ vat excluded
<i>Caboche media LED</i>	A <sup>+</sup>	trasparente	138007L 16	1.200,00
		giallo oro	138007L 52	
<i>Caboche media LED dimmable</i>	A <sup>+</sup>	trasparente	138007LD 16	1.285,00
		giallo oro	138007LD 52	
<i>Caboche media</i>	A <sup>+</sup> , C	trasparente	138007 16	869,00
		giallo oro	138007 52	
<i>Caboche media LED h. 10 m •</i>	A <sup>+</sup>	trasparente	138007L/10-16	1.291,00
		giallo oro	138007L/10-52	
<i>Caboche media LED dimmable h. 10 m •</i>	A <sup>+</sup>	trasparente	138007LD/1016	1.375,00
		giallo oro	138007LD/1052	
<i>Caboche media h. 10 m •</i>	A <sup>+</sup> , C	trasparente	138007/10-16	1.011,00
		giallo oro	138007/10-52	

### Spare parts:

<i>Kit 10 spheres Caboche</i>	trasparente	138KIT 10SF16	40,00
	giallo oro	138KIT 10SF52	
<i>Kit 15 prongs 3 spheres Caboche</i>		138KIT 15M3	30,00
<i>Kit 15 prongs 4 spheres Caboche</i>		138KIT 15M4	30,00
<i>Kit 3+3 prongs 3-4 spheres Caboche</i>		138KIT-R2	21,00
<i>Inner glass Caboche halogen</i>		138V01R1/I	81,00
<i>Inner glass Caboche LED</i>		138V018/I	93,00
<i>Halogen protection glass</i>		PIREX138/2S4I	21,00
<i>Disco protezione halogen</i>		138V02/I	38,00

### Accessories:

<i>Decentralization kit for steel cables</i>	KIT DEC B	28,00
for steel cables + canopy	KIT DEC F	49,00

Colours: trasparente,  
giallo oro

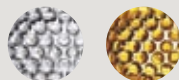

Weight:  
net kg 10,20

•  
**On demand:**  
lead times to be  
checked with the  
sales department

Light bulbs not included  
→ specifications p. 186

Decentralization  
→ specifications p. 124

LED and dimming  
→ specifications p. 185

16 - 21 LED

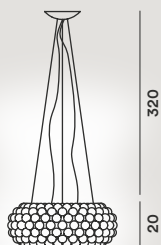

50

collection →

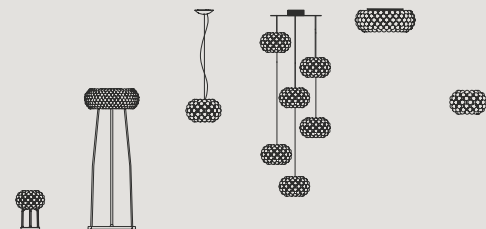

p. 020 p. 042 p. 074/077 p. 116 p. 133 p. 150



**Caboche media**  
**MyLight tunable white**

Patricia Urquiola  
con Eliana Gerotto, 2005



	energy cl.	colours	code	€ vat excluded
<i>Caboche media MyLight</i>	A <sup>+</sup>	trasparente	138007TW-16	1.285,00
<i>Tunable white</i>		giallo oro	138007TW-52	
<i>Caboche media MyLight</i>	A <sup>+</sup>	trasparente	138007TW/1016	1.375,00
<i>Tunable white h. 10 m</i> •		giallo oro	138007TW/1052	

PMMA, blown glass,  
chromed metal and  
aluminium

LED included  
28W (28 + 7 Mid power)  
2500 - 4500 K  
3525 - 3600 lm CRI>90

Dimmable via Bluetooth with  
Casambi 📶



Colours: trasparente,  
giallo oro



Weight:  
net kg 10,20

MyLight collection  
→ specifiche p. 184

•  
On demand:  
lead times to be  
checked with the  
sales department

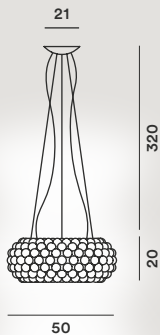

## Caboche piccola

Patricia Urquiola  
con Eliana Gerotto, 2005



PMMA, blown glass and  
chromed metal

Max 1x60W G9

⊕ CE IP 20

	energy cl.	colours	code	€ vat excluded
<i>Caboche piccola</i>	A <sup>+</sup> , A, C	trasparente	138027 16	433,00
		giallo oro	138027 52	
<i>Caboche piccola h. 10 m</i> • A <sup>+</sup> , A, C		trasparente	138027/10-16	543,00
		giallo oro	138027/10-52	

### Spare parts:

<i>Kit 10 spheres Caboche</i>	trasparente	138KIT 10SF16	40,00
	giallo oro	138KIT 10SF52	
<i>Kit 10 prongs 3 spheres Caboche</i>		138KIT 10P3	25,00
<i>Kit 10 prongs 4 spheres Caboche</i>		138KIT 10P4	25,00
<i>Kit 3+3 prongs 3-4 spheres Caboche</i>		138KIT2-R2	18,00
<i>Inner glass Caboche piccola</i>		138V012/1	43,00

### Accessories:

<i>Decentralization kit</i>	for steel cables	KIT DEC B	28,00
	for steel cables + canopy	KIT DEC F	49,00
	canopy for electrical dec.	KIT DEC M	87,00

Colours: trasparente,  
giallo oro

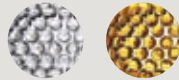

Weight:  
net kg 4,80

•  
**On demand:**  
lead times to be  
checked with the  
sales department

Light bulbs not included  
→ specifications p. 186

Multiple canopy  
→ specifications p. 116

Decentralization  
→ specifications p. 124

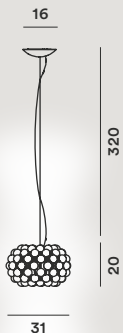

collection →

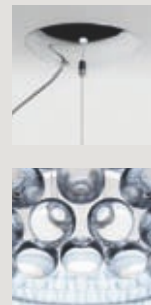
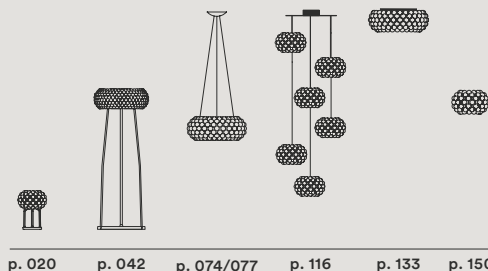

**Chouchin**

Ionna Vautrin, 2011

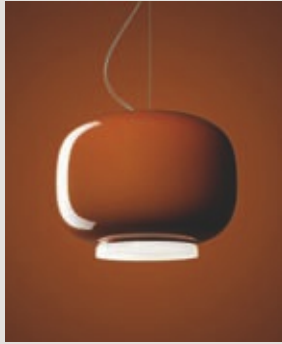

Lacquered blown glass

**Chouchin 1 - 2 - 3**  
LED retrofit included  
21W E27 2700 K  
2500 lm CRI>80  
Dimmable with  
TRIAC technology

**Chouchin 1 - 2 - 3 LED**  
included 24W COB  
2700 K 2581 lm CRI>90  
Dimmable LED version  
Possible configurations:  
On-Off/Push/DALI

⊕ CE IP 20

	energy cl.	colours	code	€ vat excluded
<b>Chouchin 1</b>	A <sup>+</sup>	arancio	210071E-53	464,00
<b>Chouchin 2</b>		verde	210072E-40	433,00
<b>Chouchin 3</b>		grigio	210073E-25	371,00
<b>Chouchin 1 LED ●</b>	A <sup>+</sup>	arancio	210071L 53	572,00
<b>Chouchin 2 LED ●</b>		verde	210072L 40	541,00
<b>Chouchin 3 LED ●</b>		grigio	210073L 25	479,00
<b>Chouchin 1 LED dimm. ●</b>	A <sup>+</sup>	arancio	210071LD 53	628,00
<b>Chouchin 2 LED dimm. ●</b>		verde	210072LD 40	597,00
<b>Chouchin 3 LED dimm. ●</b>		grigio	210073LD 25	535,00
<b>Chouchin 1 h. 10 m ●</b>	A <sup>+</sup>	arancio	210071E/10-53	508,00
<b>Chouchin 2 h. 10 m ●</b>		verde	210072E/10-40	477,00
<b>Chouchin 3 h. 10 m ●</b>		grigio	210073E/10-25	415,00
<b>Chouchin 1 LED h. 10 m ●</b>	A <sup>+</sup>	arancio	210071L/10-53	614,00
<b>Chouchin 2 LED h. 10 m ●</b>		verde	210072L/10-40	583,00
<b>Chouchin 3 LED h. 10 m ●</b>		grigio	210073L/10-25	521,00
<b>Chouchin 1 LED dimm. h. 10 m ●</b>	A <sup>+</sup>	arancio	210071LD/1053	670,00
<b>Chouchin 2 LED dimm. h. 10 m ●</b>		verde	210072LD/1040	639,00
<b>Chouchin 3 LED dimm. h. 10 m ●</b>		grigio	210073LD/1025	577,00

Colours:  
**Chouchin 1** arancio,  
**Chouchin 2** verde,  
**Chouchin 3** grigio



Weight:  
**Chouchin 1**  
net kg 4,40

**Chouchin 2**  
net kg 2,90

**Chouchin 3**  
net kg 3,60

**Chouchin 1 LED**  
net kg 5,00

**Chouchin 2 LED**  
net kg 3,50

**Chouchin 3 LED**  
net kg 4,20

Multiple canopy  
→ specifications p. 116

Decentralization  
→ specifications p. 124

LED and dimming  
→ specifications p. 185

● **On demand:**  
lead times to be  
checked with the sales  
department

Tecnico — 2019

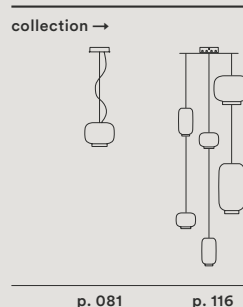
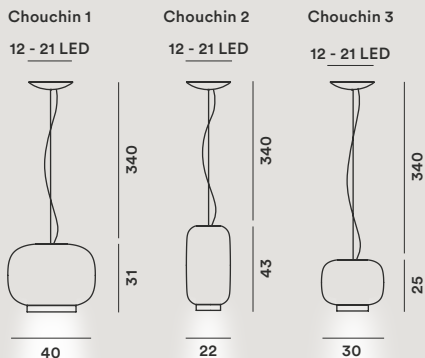

## Chouchin reverse

Ionna Vautrin, 2015



Lacquered blown glass

*Chouchin 1 - 2 - 3 reverse*

LED retrofit included

21W E27 2700 K

2500 lm CRI>80

Dimmable with

TRIAC technology

*Chouchin 1 - 2 - 3 LED reverse*

included 24W COB

2700 K 2581 lm CRI>90

Dimmable LED version

Possible configurations:

On-Off/Push/DALI

⊕ CE IP 20

	energy cl.	colours	code	€ vat excluded
<i>Chouchin 1 reverse</i>	A <sup>+</sup>	bianco/arancio	210071E-05	464,00
<i>Chouchin 2 reverse</i>		bianco/verde	210072E-04	433,00
<i>Chouchin 3 reverse</i>		bianco/grigio	210073E-02	371,00
<i>Chouchin 1 reverse LED ●</i>	A <sup>+</sup>	bianco/arancio	210071L 05	572,00
<i>Chouchin 2 reverse LED ●</i>		bianco/verde	210072L 04	541,00
<i>Chouchin 3 reverse LED ●</i>		bianco/grigio	210073L 02	479,00
<i>Chouchin 1 rev. LED dimm. ●</i>	A <sup>+</sup>	bianco/arancio	210071LD 05	628,00
<i>Chouchin 2 rev. LED dimm. ●</i>		bianco/verde	210072LD 04	597,00
<i>Chouchin 3 rev. LED dimm. ●</i>		bianco/grigio	210073LD 02	535,00
<i>Chouchin 1 rev. h. 10 m ●</i>	A <sup>+</sup>	bianco/arancio	210071E/10-05	508,00
<i>Chouchin 2 rev. h. 10 m ●</i>		bianco/verde	210072E/10-04	477,00
<i>Chouchin 3 rev. h. 10 m ●</i>		bianco/grigio	210073E/10-02	415,00
<i>Chouchin 1 rev. LED h. 10 m ●</i>	A <sup>+</sup>	bianco/arancio	210071L/10-05	614,00
<i>Chouchin 2 rev. LED h. 10 m ●</i>		bianco/verde	210072L/10-04	583,00
<i>Chouchin 3 rev. LED h. 10 m ●</i>		bianco/grigio	210073L/10-02	521,00
<i>Chouchin 1 rev. LED dimm. h. 10 m ●</i>	A <sup>+</sup>	bianco/arancio	210071LD/1005	670,00
<i>Chouchin 2 rev. LED dimm. h. 10 m ●</i>		bianco/verde	210072LD/1004	639,00
<i>Chouchin 3 rev. LED dimm. h. 10 m ●</i>		bianco/grigio	210073LD/1002	577,00

Colours:

*Chouchin reverse 1*

bianco / arancio

*Chouchin reverse 2*

bianco / verde

*Chouchin reverse 3*

bianco / grigio

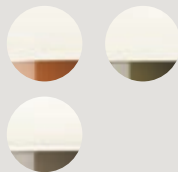

Weight:

*Chouchin rev. 1*

net kg 4,40

*Chouchin rev. 2*

net kg 2,90

*Chouchin rev. 3*

net kg 3,60

*Chouchin rev. 1 LED*

net kg 5,00

*Chouchin rev. 2 LED*

net kg 3,50

*Chouchin rev. 3 LED*

net kg 4,20

Multiple canopy

→ specifications p. 116

Decentralization

→ specifications p. 124

LED and dimming

→ specifications p. 185

●  
**On demand:**  
lead times to be checked  
with the sales department

Chouchin 1

12 - 21 LED



40

Chouchin 2

12 - 21 LED



22

Chouchin 3

12 - 21 LED



30

collection →

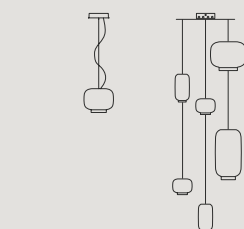

p. 081

p. 116

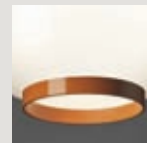

## 080 Sospensione, *Suspension*

### Spare parts:

	energy cl.	colours	code	€ vat excluded
<i>Glass Chouchin 1</i>		arancio	210S001E-53	315,00
<i>Glass Chouchin 2</i>		verde	210S002E-40	284,00
<i>Glass Chouchin 3</i>		grigio	210S003E-25	222,00
<i>Glass Chouchin 1 LED</i>		arancio	210S001R1 53	315,00
<i>Glass Chouchin 2 LED</i>		verde	210S002R1 40	284,00
<i>Glass Chouchin 3 LED</i>		grigio	210S003R1 25	222,00
<i>Glass Chouchin 1 reverse</i>		bianco/arancio	210S001E-05	315,00
<i>Glass Chouchin 2 reverse</i>		bianco/verde	210S002E-04	284,00
<i>Glass Chouchin 3 reverse</i>		bianco/grigio	210S003E-02	222,00
<i>Glass Chouchin 1 reverse LED</i>		bianco/arancio	210S001R1 05	315,00
<i>Glass Chouchin 2 reverse LED</i>		bianco/verde	210S002R1 04	284,00
<i>Glass Chouchin 3 reverse LED</i>		bianco/grigio	210S003R1 02	222,00

### Accessories:

<i>Decentralization kit</i> for steel cables			KIT DEC B	28,00
			for steel cables + canopy	49,00
			canopy for electrical dec.	87,00

Multiple canopy  
→ specifications p. 116

Decentralization  
→ specifications p. 124

Chouchin 1

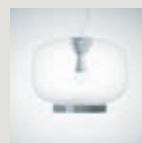

Chouchin 2

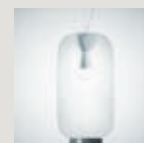

Chouchin 3

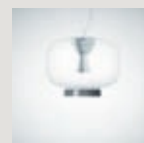

## Chouchin mini

Ionna Vautrin, 2013



Lacquered blown glass

Max 1x35W GU10 PAR 16

⊕ CE IP 20

	energy cl.	colours	code	€ vat excluded
<i>Chouchin mini 1</i>	A <sup>+</sup> , A, C	arancio	210271R1-53	234,00
<i>Chouchin mini 2</i>	A <sup>+</sup> , A, C	verde	210272R1-40	257,00
<i>Chouchin mini 1 h. 10 m</i> •	A <sup>+</sup> , A, C	arancio	210271R1/1053	278,00
<i>Chouchin mini 2 h. 10 m</i> •	A <sup>+</sup> , A, C	verde	210272R1/1040	301,00

### Spare parts:

<i>Glass Chouchin mini 1</i>	arancio	210S021 53	120,00
<i>Glass Chouchin mini 2</i>	verde	210S022 40	120,00

### Accessories:

<i>Decentralization kit</i> for steel cables	KIT DEC B	28,00
for steel cables + canopy	KIT DEC F	49,00
canopy for electrical dec.	KIT DEC M	87,00

### Colours:

*Chouchin mini 1* arancio,  
*Chouchin mini 2* verde



### Weight:

*Chouchin mini 1*  
net kg 1,00

*Chouchin mini 2*  
net kg 1,10

•

### On demand:

lead times to be  
checked with the  
sales department

### Light bulbs not included

→ specifications p. 186

### Multiple canopy

→ specifications p. 116

### Decentralization

→ specifications p. 124

mini 1



mini 2

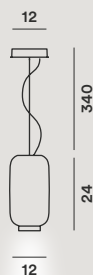

collection →

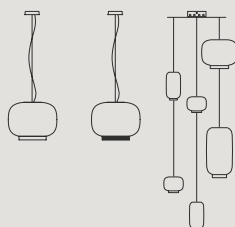

p. 078

p. 079

p. 116



## Caiigo

Marco Zito, 2016



Blown glass and aluminium

Max 1x35W GU10 PAR 16

⊕ CE IP 20

	energy cl.	colours	code	€ vat excluded	
<i>Caiigo</i>	A <sup>+</sup> , A, C	bianco	266007R1-15	426,00	
<i>Caiigo h. 10 m •</i>	A <sup>+</sup> , A, C	bianco	266007R1/1015	491,00	
<b>Spare parts:</b>					
<i>Lampshade Caiigo</i>		bianco	266S00 15	249,00	
<b>Accessories:</b>					
<i>Decentralization kit</i> for steel cables			KIT DEC B	28,00	
			for steel cables + canopy	KIT DEC F	49,00
			canopy for electrical dec.	KIT DEC M	87,00

Colours: bianco sfumato



Weight:  
net kg 2,00

•

**On demand:**  
lead times to be  
checked with the  
sales department

Light bulbs not included  
→ specifications p. 186

Multiple canopy  
→ specifications p. 116

Decentralization  
→ specifications p. 124

Tecnico — 2019

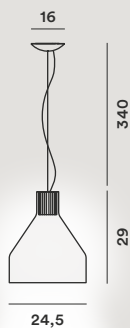



## Dolmen

Ferruccio Laviani,  
1996/2017

LED



	energy cl.	colours	code	€ vat excluded
<i>Dolmen</i>	A <sup>+</sup>	alluminio	280007-25	1.371,00
		arancio	280007-14	1.517,00
		bronzo	280007-73	1.517,00
<i>Dolmen h. 10 m •</i>	A <sup>+</sup>	alluminio	280007/10-25	1.598,00
		arancio	280007/10-14	1.744,00
		bronzo	280007/10-73	1.744,00

Varnished or anodised  
aluminium

LED included  
47W Mid power 2700 K  
6486 lm CRI>90  
Dimmable  
Possible configurations:  
On-Off/Push/DALI

⊕ CE IP 20

Colours:  
alluminio, arancione,  
bronzo



Weight:  
net kg 12,50

•  
On demand:  
lead times to be  
checked with the  
sales department

LED and dimming  
→ specifications p. 185

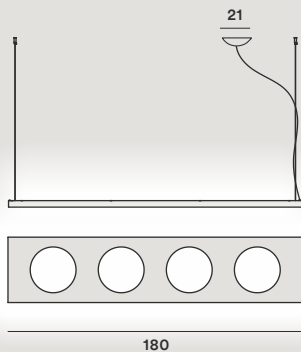

collection →



p. 043



**Gem**

Ludovica + Roberto  
Palomba, 2017



Blown acid-etched glass with reliefs

**Gem**  
LED retrofit included  
21W E27 2700 K  
2500 lm CRI>80  
Dimmable with TRIAC technology

**Gem LED**  
included 24W COB 2700 K  
2581 lm CRI>90  
Dimmable version  
Possible configurations:  
On-Off/Push/DALI

⊕ CE IP 20



	energy cl.	colours	code	€ vat excluded
<b>Gem</b>	A+, A	bianco	274007E-10	451,00
<b>Gem LED •</b>	A+	bianco	274007L-10	508,00
<b>Gem LED dimmable •</b>	A+	bianco	274007LD-10	564,00
<b>Gem h. 10 m •</b>	A+, A	bianco	274007E10-10	496,00
<b>Gem LED h. 10 m •</b>	A+	bianco	274007L/10-10	550,00
<b>Gem LED dimm. h. 10 m •</b>	A+	bianco	274007LD/1010	606,00

**Spare parts:**

<b>Glass Gem</b>	bianco	274S00-10	251,00
<b>Glass Gem LED</b>	bianco	274S007-10	251,00

**Accessories:**

<b>Decentralization kit</b> for steel cables		KIT DEC B	28,00
	for steel cables + canopy	KIT DEC F	49,00
	canopy for electrical dec.	KIT DEC M	87,00

Colours: bianco



Weight:  
net kg 4,60

LED and dimming  
→ specifications p. 185

• **On demand:**  
lead times to be checked with the sales department

Tecnico — 2019

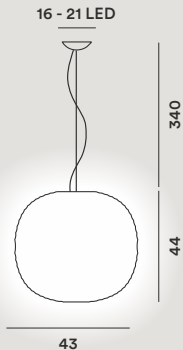

43



p. 022



**Giga-Lite**

Marc Sadler, 2004



Fiberglass fabric with carbonium thread, steel and nickel-plated metal

Max 3x77W E27

⊕ CE IP 20

	energy cl.	colours	code	€ vat excluded	
<i>Giga-Lite</i>	A <sup>+</sup> , A	nero	139017 20	700,00	
<i>Giga-Lite h. 10 m •</i>	A <sup>+</sup> , A	nero	139017/10-20	774,00	
<b>Spare parts:</b>					
<i>Lampshade Giga-Lite</i>		nero	139S001 20	379,00	
<b>Accessories:</b>					
<i>Decentralization kit</i> for power cable			KIT DEC C	33,00	
			canopy for electrical dec.	KIT DEC M	87,00

Colours: nero



Weight:  
net kg 2,50

Light bulbs not included  
→ specifications p. 186

Decentralization  
→ specifications p. 124

•  
**On demand:**  
lead times to be  
checked with the  
sales department

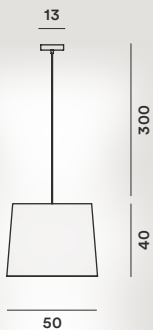

collection →

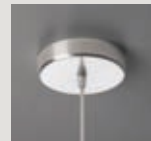
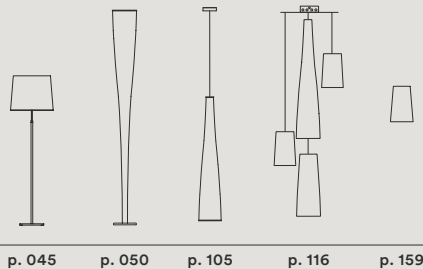

**Gregg**

Ludovica + Roberto  
Palomba, 2007



	energy cl.	colours	code	€ vat excluded
<i>Gregg grande</i>	A <sup>+</sup> , A	bianco	1680071E-10	531,00
<i>Gregg media</i>	A <sup>+</sup>	bianco	168007E-10	329,00
<i>Gregg MIDI</i>	A <sup>+</sup>	bianco	1680073-10	280,00
<i>Gregg piccola</i>	A <sup>+</sup> , A, C	bianco	1680072R1-10	159,00
<i>Gregg grande LED •</i>	A <sup>+</sup>	bianco	1680071L 10	591,00
<i>Gregg grande LED dimm. •</i>	A <sup>+</sup>	bianco	1680071LD 10	647,00
<i>Gregg media LED •</i>	A <sup>+</sup>	bianco	168007L 10	437,00
<i>Gregg media LED dimm. •</i>	A <sup>+</sup>	bianco	168007LD 10	493,00

Blown acid-etched glass

*Gregg grande/media*  
LED retrofit included  
21W E27 2700 K  
2500 lm CRI > 80  
Dimmable with  
TRIAC technology

*Gregg MIDI*  
LED included COB 8,5W  
2700 K 830 lm CRI>80  
Dimmable with  
TRIAC technology

*Gregg piccola*  
Max 1x33W G9

*Gregg grande/media LED*  
LED included  
24W COB 2700 K  
2581 lm CRI>90  
Dimmable version  
Possible configurations:  
On-Off/Push/DALI



Colours: bianco



Weight:

*Gregg grande*  
net kg 5,60

*Gregg media*  
net kg 3,20

*Gregg MIDI*  
net kg 1,60

*Gregg piccola*  
net kg 0,70

*Gregg grande LED*  
net kg 6,20

*Gregg media LED*  
net kg 3,80

Light bulbs not included  
→ specifications p. 186

Multiple canopy  
→ specifications p. 116

Decentralization  
→ specifications p. 124

LED and dimming  
→ specifications p. 185

Tecnico — 2019

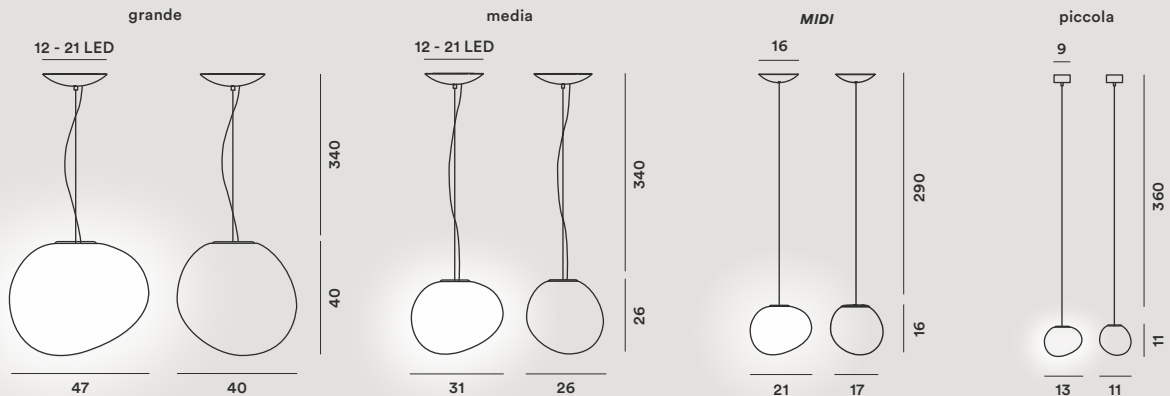

	energy cl.	colours	code	€ vat excluded
<i>Gregg grande h. 10 m •</i>	A <sup>+</sup> , A	bianco	1680071E10-10	576,00
<i>Gregg media h. 10 m •</i>	A <sup>+</sup>	bianco	168007E/10-10	373,00
<i>Gregg MIDI h. 10 m •</i>	A <sup>+</sup>	bianco	1680073/10-10	306,00
<i>Gregg piccola h. 10 m •</i>	A <sup>+</sup> , A, C	bianco	1680072R11010	226,00
<i>Gregg grande LED h. 10 m •</i>	A <sup>+</sup>	bianco	1680071L/1010	633,00
<i>Gregg grande LED h. 10 m dimm. •</i>	A <sup>+</sup>	bianco	1680071LD1010	689,00
<i>Gregg media LED h. 10 m •</i>	A <sup>+</sup>	bianco	168007L/10-10	479,00
<i>Gregg media LED h. 10 m dimm. •</i>	A <sup>+</sup>	bianco	168007LD/1010	535,00

**Spare parts:**

<i>Glass Gregg grande</i>	bianco	168S001E-10	331,00
<i>Glass Gregg grande LED</i>	bianco	168S001 10	334,00
<i>Glass Gregg media</i>	bianco	168S00E-10	180,00
<i>Glass Gregg media LED</i>	bianco	168S007R1 10	180,00
<i>Glass Gregg MIDI</i>	bianco	168S003-10	91,00
<i>Glass Gregg piccola</i>	bianco	168S00210	60,00

**Accessories:**

<i>Decentralization kit</i>	for steel cables	KIT DEC B	28,00
<i>Gregg grande/media</i>	for steel cables + canopy	KIT DEC F	49,00
<i>Gregg piccola</i>	for power cable	KIT DEC C	33,00
	canopy for electrical dec.	KIT DEC M	87,00

•  
**On demand:**  
 lead times to be checked  
 with the sales department

collection →

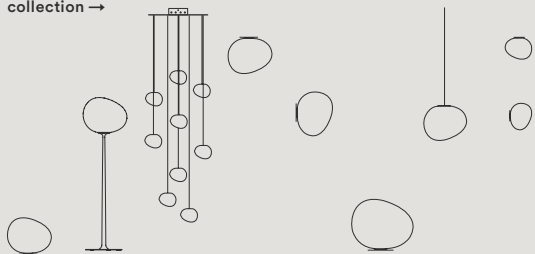

p. 023/031 p. 046 p. 116 p. 136 p. 156 p. 173 p. 179 p. 183

MIDI

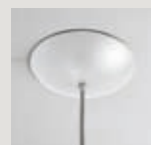

media/grande



piccola



## Havana

Joseph Forakis, 1993



	energy cl.	colours	code	€ vat excluded
<i>Havana</i>	A <sup>+</sup> , A	bianco	0400072-R1 10	223,00
<i>Havana h. 10 m</i> •	A <sup>+</sup> , A	bianco	0400072/10-10	298,00
<i>Havana doppia</i> •	A <sup>+</sup> , A	bianco	0400072SP2 10	937,00
<i>Havana tripla</i> •	A <sup>+</sup> , A	bianco	0400072SP3 10	1.359,00
<i>Havana quadrupla</i> •	A <sup>+</sup> , A	bianco	0400072SP4 10	1.781,00

### Spare parts:

<i>Set lampshades Havana</i>	bianco	040S00 10	81,00
------------------------------	--------	-----------	-------

### Accessories:

<i>Decentralization kit</i> for power cable		KIT DEC C	33,00
	canopy for electrical dec.	KIT DEC M	87,00

Injection moulded polyethylene and coated metal

Max 1x105W E27

Ⓢ ⒸⒺ Ⓜ IP 20

*Havana doppia, tripla, quadrupla*

Ⓢ ⒸⒺ IP 20

Colours: bianco



Weight:  
net kg 1,90

•  
**On demand:**  
lead times to be checked with the sales department

Light bulbs not included  
→ specifications p. 186

Multiple canopy  
→ specifications p. 116

Decentralization  
→ specifications p. 124

doppia tripla quadrupla

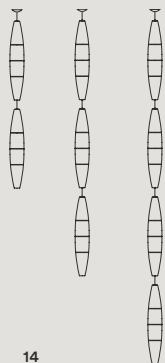

14

260

130

23

collection →

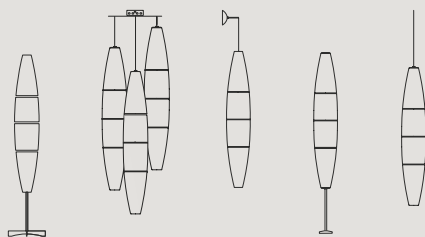

p. 047

p. 116

p. 157

p. 174

p. 180

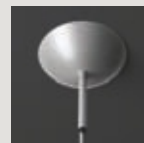

## Le Soleil

Vincente Garcia Jimenez,  
2009

LED

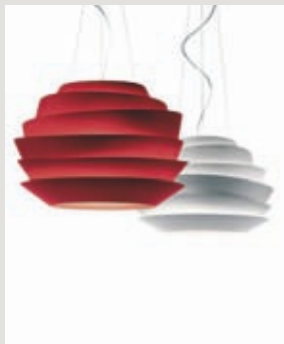

Injection moulded  
polycarbonate and coated  
metal

*Le Soleil*  
Max 3x70W E27 +  
1x75W GU10 PAR 16

*Le Soleil LED* included  
46W 2700 K  
4460 lm CRI>90  
dimnable

Possible configurations:  
On-Off/Push/DALI

⊕ Ⓢ Ⓜ IP 20

	energy cl.	colours	code	€ vat excluded
<i>Le Soleil</i>	A <sup>+</sup> , A	bianco	181007 10	556,00
		rosso	181007 63	776,00
		bronzo	181007-73	
		rame	181007-80	
<i>Le Soleil LED</i>	A <sup>+</sup>	bianco	181007L-10	583,00
		rosso	181007L-63	803,00
		bronzo	181007L-73	
		rame	181007L-80	
<i>Le Soleil LED dimmable</i>	A <sup>+</sup>	bianco	181007LD-10	671,00
		rosso	181007LD-63	891,00
		bronzo	181007LD-73	
		rame	181007LD-80	
<i>Le Soleil h. 10 m •</i>	A <sup>+</sup> , A	bianco	181007/10-10	633,00
		rosso	181007/10-63	853,00
		bronzo	181007/10-73	
		rame	181007/10-80	
<i>Le Soleil LED h. 10 m •</i>	A <sup>+</sup>	bianco	181007L/10-10	659,00
		rosso	181007L/10-63	879,00
		bronzo	181007L/10-73	
		rame	181007L/10-80	
<i>Le Soleil LED dimmable h. 10 m •</i>	A <sup>+</sup>	bianco	181007LD/1010	747,00
		rosso	181007LD/1063	967,00
		bronzo	181007LD/1073	
		rame	181007LD/1080	
<b>Accessories:</b>				
<i>Decentralization kit</i> for steel cables			KIT DEC B	28,00
for steel cables + canopy			KIT DEC F	49,00
canopy for electrical dec.			KIT DEC M	87,00

Colours: bianco, rosso,  
rame, bronzo

Weight:  
net kg 5,30

Light bulbs not included  
→ specifications p. 186



•  
**On demand:**  
lead times to be  
checked with the  
sales department

Decentralization  
→ specifications p. 124

LED and dimming  
→ specifications p. 185

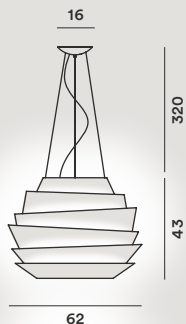

collection →



p. 161

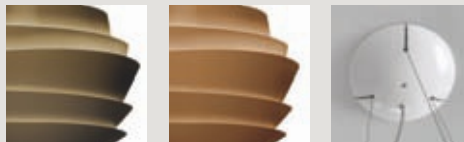





**Lightweight**

Tom Dixon, 1995



	energy cl.	colours	code	€ vat excluded
<i>Lightweight</i>	A <sup>+</sup> , A, C	anodizzato	064007-R1/3ZI	3.271,00
<i>Lightweight h. 10 m •</i>	A <sup>+</sup> , A, C	anodizzato	064007-R1/10Z	3.516,00
<b>Spare parts:</b>				
<i>Glass</i>		bianco	061V01/I	23,00
<b>Accessories:</b>				
<i>Decentralization kit</i> for steel cables			KIT DEC B	28,00

Anodized metal

Max 8x2W G4 12V

IP 20

Colours: anodizzato

Weight:  
net kg 7,60Light bulbs not included  
→ specifications p. 186

•  
**On demand:**  
lead times to be  
checked with the  
sales department

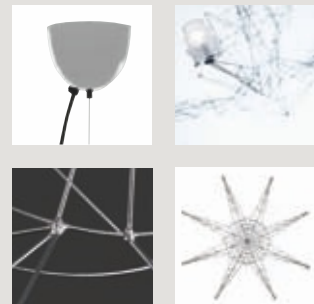
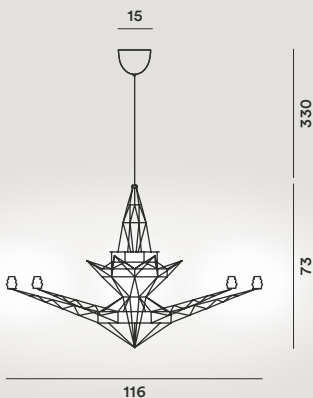

**Maki**

Nendo, 2011



	energy cl.	colours	code	€ vat excluded
<b>Maki</b>	A+, A, C	bianco	219007R1-10	245,00
		grigio	219007R1-25	
<b>Maki h. 10 m •</b>	A+, A, C	bianco	219007R1/1010	305,00
		grigio	219007R1/1025	
<b>Accessories:</b>				
<b>Decentralization kit</b> for power cable			KIT DEC C	33,00
canopy for electrical dec.			KIT DEC M	87,00

Lacquered aluminium

Max 1x8W GU10 PAR 16



Colours: bianco, grigio



Weight:  
net kg 0,50

•

**On demand:**  
lead times to be  
checked with the  
sales department

Light bulbs not included  
→ specifications p. 186

Multiple canopy  
→ specifications p. 116

Decentralization  
→ specifications p. 124

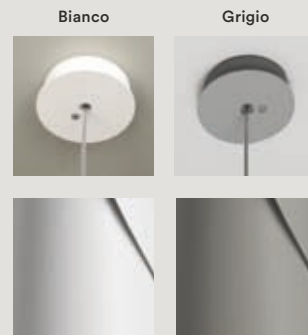

## O-Space

Luca Nichetto  
e Gianpietro Gai, 2003



	energy cl.	colours	code	€ vat excluded
O-Space	A <sup>+</sup> , A, C	bianco	127007/3-10	738,00
O-Space h. 10 m •	A <sup>+</sup> , A, C	bianco	127007 10/SP1	853,00

### Spare parts:

Protection glass	bianco	PIREX94/3/I	21,00
Protection disk		PIREX D100/3I	31,00

### Accessories:

Decentralization kit for steel cables		KIT DEC B	28,00
for steel cables + canopy		KIT DEC F	49,00
canopy for electrical dec.		KIT DEC M	87,00

Expanded polyurethane and  
chrome metal

Max 1x120W R7s

⊕ CE IP 20

Colours: bianco



Weight:  
net kg 4,40

•  
**On demand:**  
lead times to be  
checked with the  
sales department

Light bulbs not included  
→ specifications p. 186

Decentralization  
→ specifications p. 124

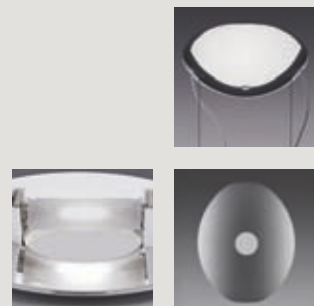
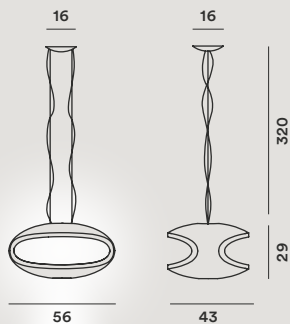

**Plass grande**

Luca Nichetto, 2011



Rotational moulded polycarbonate and aluminium

*Plass grande LED* included  
30W Lite-on 3000 K  
2500 lm CRI>80  
+ LED retrofit included  
1x9,5W 2700 K 650 lm  
E27 PAR 30

*Plass grande*  
Max 6x60W G9  
+ 1x100W E27 PAR 30

Double switch



	energy cl.	colours	code	€ vat excluded
<i>Plass grande LED</i>	A+, A	grigio	2240071L 25	2.806,00
		azzurro	2240071L 30	
<i>Plass grande</i>	A+, A, C	grigio	2240071 25	2.364,00
		azzurro	2240071 30	
<i>Plass grande LED h. 10 m</i> •	A+, A	grigio	2240071L/1025	2.884,00
		azzurro	2240071L/1030	
<i>Plass grande h. 10 m</i> •	A+, A, C	grigio	2240071/10-25	2.431,00
		azzurro	2240071/10-30	

**Spare parts:**

<i>Lampshade Plass</i>	grigio	224S001 25	1.130,00
	azzurro	224S001 30	

**Accessories:**

<i>Decentralization kit</i> for steel cables	KIT DEC B	28,00
for steel cables + canopy	KIT DEC F	49,00
canopy for electrical dec.	KIT DEC M	87,00

Colours: grigio, azzurro

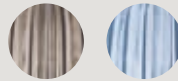

Weight:  
net kg 23,00

•  
**On demand:**  
lead times to be  
checked with the  
sales department

Light bulbs not included  
→ specifications p. 186

Decentralization  
→ specifications p. 124

LED and dimming  
→ specifications p. 185

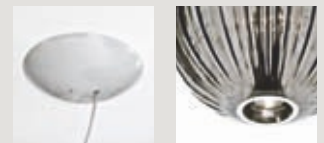
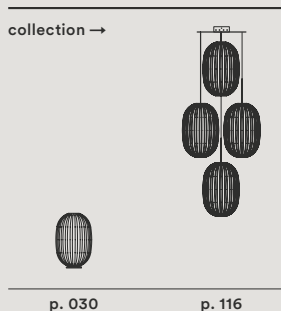
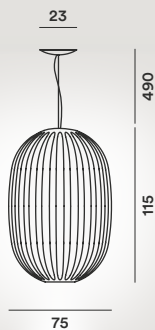

## Plass media

Luca Nichetto, 2015



Rotational moulded  
polycarbonate and steel

*Plass media E27+GU10*  
Max 1x116W E27  
+ 1x75W GU10 PAR 20

*Plass media E27*  
Max 1x116W E27

⊕ CE IP 20

doppia tripla quadrupla

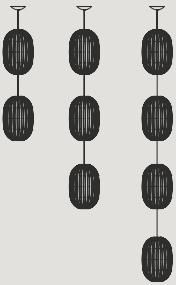

34

	energy cl.	colours	code	€ vat excluded
<i>Plass media E27+GU10</i>	A <sup>+</sup> , A	grigio	2240072 25	518,00
		azzurro	2240072 30	
<i>Plass media 1 x E27</i>	A <sup>+</sup> , A	grigio	2240172 25	430,00
		azzurro	2240172 30	
<i>Plass media E27+GU10 h. 10 m</i> •	A <sup>+</sup> , A	grigio	2240072/10-25	604,00
		azzurro	2240072/10-30	
<i>Plass media 1 x E27 h. 10 m</i> •	A <sup>+</sup> , A	grigio	2240172/10-25	516,00
		azzurro	2240172/10-30	
<i>Plass media doppia</i> •	A <sup>+</sup> , A	grigio	2240072/2 25	1.077,00
		azzurro	2240072/2 30	
<i>Plass media tripla</i> •	A <sup>+</sup> , A	grigio	2240072/3 25	1.544,00
		azzurro	2240072/3 30	
<i>Plass media quadrupla</i> •	A <sup>+</sup> , A	grigio	2240072/4 25	2.011,00
		azzurro	2240072/4 30	
<b>Spare parts:</b>				
<i>Lampshade Plass media</i>		grigio	224S002R1 25	253,00
		azzurro	224S002R1 30	

Colours: grigio, azzurro

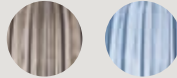

Weight:  
net kg 3,50

Light bulbs not included  
→ specifications p. 186

Multiple canopy  
→ specifications p. 116

•  
**On demand:**  
lead times to be  
checked with the  
sales department

Decentralization  
→ specifications p. 124

collection →

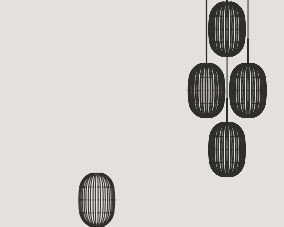

p. 030

p. 116

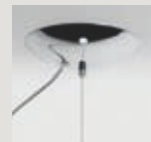

**Rituals + Rituals XL**

Ludovica + Roberto  
Palomba, 2013-2015



	energy cl.	colours	code	€ vat excluded
<i>Rituals 1</i>	A <sup>+</sup> , A	bianco	2440071E 10	378,00
<i>Rituals 2</i>	A <sup>+</sup> , A	bianco	2440072E 10	378,00
<i>Rituals 3</i>	A <sup>+</sup> , A	bianco	2440073E 10	322,00
<i>Rituals XL</i>	A <sup>+</sup> , A	bianco	2440074E-10	538,00
<i>Rituals XL LED</i> •	A <sup>+</sup>	bianco	2440074L 10	588,00
<i>Rituals XL LED dimmable</i> •	A <sup>+</sup>	bianco	2440074LD 10	644,00
<i>Rituals 1 h. 10 m</i> •	A <sup>+</sup> , A	bianco	2440071E/1010	443,00
<i>Rituals 2 h. 10 m</i> •	A <sup>+</sup> , A	bianco	2440072E/1010	443,00
<i>Rituals 3 h. 10 m</i> •	A <sup>+</sup> , A	bianco	2440073E/1010	387,00
<i>Rituals XL h. 10 m</i> •	A <sup>+</sup> , A	bianco	2440074E10-10	583,00
<i>Rituals XL LED h. 10 m</i> •	A <sup>+</sup>	bianco	2440074L/1010	630,00
<i>Rituals XL LED dimm. h. 10 m</i> •	A <sup>+</sup>	bianco	2440074LD1010	686,00

Blown engraved satin glass and lacquered metal

*Rituals 1-2-3*  
Max 1x70W E27

*Rituals XL*  
LED retrofit included  
21W E27 2700 K  
2500 lm CRI > 80  
Dimmable with TRIAC technology

*Rituals XL LED*  
included 24W COB  
2700 K 2581 lm CRI>90  
Dimmable version  
Possible configurations:  
On-Off/Push/DALI



Colours: bianco



Weight:  
*Rituals 1*  
net kg 3,80

*Rituals 2*  
net kg 4,00

*Rituals 3*  
net kg 1,50

*Rituals XL*  
net kg 6,30

*Rituals XL LED*  
net kg 6,70

•  
**On demand:**  
lead times to be checked with the sales department

Light bulbs not included  
→ specifications p. 186

Multiple canopy  
→ specifications p. 116

Decentralization  
→ specifications p. 124

LED and dimming,  
*Rituals XL LED*  
→ specifications p. 185

Tecnico — 2019

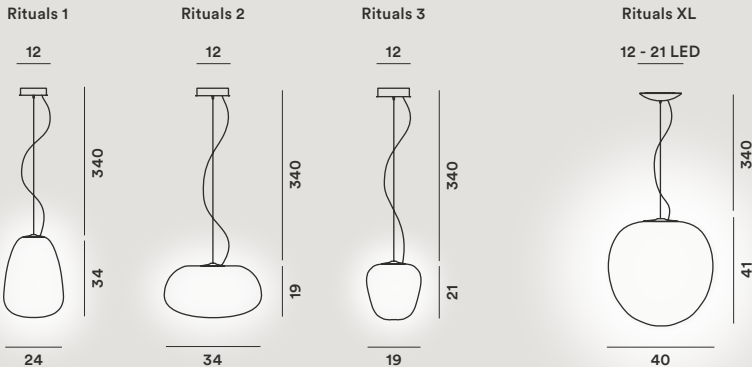

**Spare parts:**

	energy cl.	colours	code	€ vat excluded
<i>Glass Rituals 1</i>		bianco	244S001 10	226,00
<i>Glass Rituals 2</i>		bianco	244S002 10	226,00
<i>Glass Rituals 3</i>		bianco	244S003 10	170,00
<i>Glass Rituals XL</i>		bianco	244S004E-10	338,00
<i>Glass Rituals XL LED</i>		bianco	244S004 10	331,00

**Accessories:**

<i>Decentralization kit</i> for steel cables			KIT DEC B	28,00	
			for steel cables + canopy	KIT DEC F	49,00
			canopy for electrical dec.	KIT DEC M	87,00

collection →

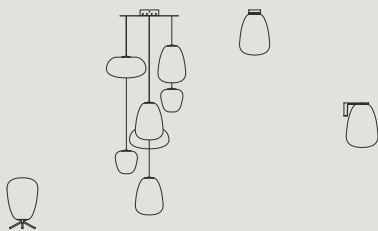

p. 032/033

p. 116

p. 139

p. 164

Rituals XL



Rituals 1 - 2 - 3

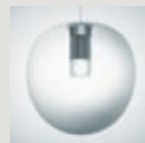

**Plena +  
Plena MyLight**

Eugenio Gargioni e  
Guillaume Albouy, 2017



	energy cl.	colours	code	€ vat excluded
<i>Plena</i>	A <sup>+</sup>	bianco	283007-10	816,00
<i>Plena dimmable</i> •		bianco	283007D-10	850,00
<i>Plena MyLight</i>		bianco	283007ML-10	850,00
<i>Plena h. 10 m</i> •		bianco	283007/10-10	879,00
<i>Plena dimmable h. 10 m</i> •		bianco	283007D/10-10	914,00
<i>Plena MyLight dimmable h. 10 m</i> •		bianco	283007ML/1010	914,00

Varnished PVC and  
aluminium

LED included  
32 W 2700 K  
3530 lm CRI>90

Dimmable version  
Possible configurations:  
On-Off/Push/DALI

*Plena MyLight*  
Dimmable via Bluetooth with  
Casambi »

⊕ CE IP 20

Colours: bianco



Weight:  
net kg 2,20

MyLight collection  
→ specifiche p. 184

•  
On demand:  
lead times to be  
checked with the  
sales department

Tecnico — 2019

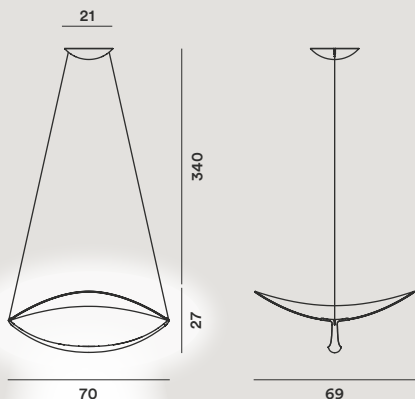



**Satellite**

Eugeni Quitllet, 2017



Blown glass

LED retrofit included  
 21W E27 2700 K  
 2500 lm CRI>80  
 Dimmable with  
 TRIAC technology



	energy cl.	colours	code	€ vat excluded
<i>Satellite</i>	A <sup>+</sup>	bianco/trasp.	285007/3-15	605,00
<i>Satellite h. 10 m •</i>	A <sup>+</sup>	bianco/trasp.	285007/10-15	646,00

**Spare parts:**

<i>External glass</i>	trasparente	285RV071-15	456,00
<i>Inner glass</i>	bianco	285RV072-10	94,00

**Accessories:**

<i>Decentralization kit</i> for steel cables		KIT DEC B	28,00
	for steel cables + canopy	KIT DEC F	49,00
	canopy for electrical dec.	KIT DEC M	87,00

Colours:  
 bianco/trasparente



Weight:  
 net kg 5,50

LED and dimming,  
 → specifications p. 185

•  
**On demand:**  
 lead times to be  
 checked with the  
 sales department

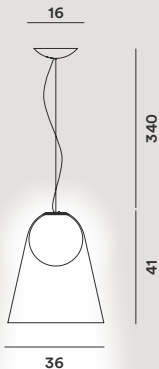

collection →

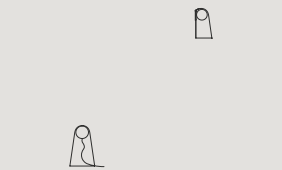

p. 034

p. 165



**Spokes +  
Spokes 2 large**

Garcia Cumini, 2015 - 2016



Varnished steel and aluminium

*Spokes 1, 2 and large*  
LED included  
30W (25 + 5)  
2700 K 3220 lm CRI>90

Dimmable version  
Possible configurations:  
On-Off/Push/DALI



	energy cl.	colours	code	€ vat excluded
<i>Spokes 1</i>	A	bianco	2640071R1-10	887,00
		giallo	2640071R1-55	
		grafite	2640071R1-22	956,00
		rame	2640071R1-80	
<i>Spokes 1 dimmable</i>	A	bianco	2640071DR1-10	947,00
		giallo	2640071DR1-55	
		grafite	2640071DR1-22	1.016,00
		rame	2640071DR1-80	
<i>Spokes 2</i>	A	bianco	2640072R1-10	872,00
		giallo	2640072R1-55	
		grafite	2640072R1-22	940,00
		rame	2640072R1-80	
<i>Spokes 2 dimmable</i>	A	bianco	2640072DR1-10	932,00
		giallo	2640072DR1-55	
		grafite	2640072DR1-22	1.000,00
		rame	2640072DR1-80	
<i>Spokes 2 large</i>	A	bianco	2640172R1-10	1.371,00
		giallo	2640172R1-55	
		grafite	2640172R1-22	1.463,00
		rame	2640172R1-80	

Colours: bianco, giallo, grafite, rame

Weight:  
*Spokes 1*  
net kg 4,40

*Spokes 2*  
net kg 4,40

*Spokes 2 Large*  
net kg 6,00

Decentralization  
→ specifications p. 124

LED and dimming,  
→ specifications p. 185



Tecnico — 2019

Spokes 1

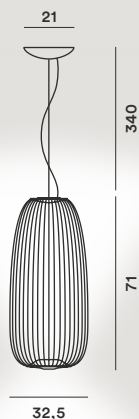

Spokes 2

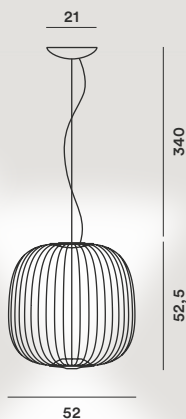

Spokes 2 large

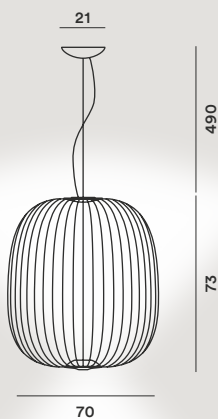

	energy cl.	colours	code	€ vat excluded	
<b>Spokes 1 h. 10 m •</b>	A	bianco	2640071R11010	952,00	
		giallo	2640071R11055		
		grafite	2640071R11022	1.021,00	
		rame	2640071R11080		
<b>Spokes 1 dimmerabile h. 10 m •</b>	A	bianco	2640071DR1110	1.012,00	
		giallo	2640071DR1155		
		grafite	2640071DR1122	1.081,00	
		rame	2640071DR1180		
<b>Spokes 2 h. 10 m •</b>	A	bianco	2640072R11010	937,00	
		giallo	2640072R11055		
		grafite	2640072R11022	1.005,00	
		rame	2640072R11080		
<b>Spokes 2 dimmerabile h. 10 m •</b>	A	bianco	2640072DR1110	997,00	
		giallo	2640072DR1155		
		grafite	2640072DR1122	1.065,00	
		rame	2640072DR1180		
<b>Spokes 2 large dimmerabile h. 10 m •</b>	A	bianco	2640172R11010	1.421,00	
		giallo	2640172R11055		
		grafite	2640172R11022	1.513,00	
		rame	2640172R11080		
<b>Accessories:</b>			<b>Decentralization kit for steel cables</b>	KIT DEC B	28,00

•  
**On demand:**  
lead times to be checked  
with the sales department



**Spokes MyLight +  
Spokes 2 large  
MyLight**

Garcia Cumini, 2015 - 2016



Varnished steel and aluminium

LED included  
30W (25 + 5)  
2700 K 3220 lm CRI>90

Dimmable via Bluetooth with Casambi »

Ⓢ Ⓢ Ⓢ IP 20



	energy cl.	colours	code	€ vat excluded
<b>Spokes 1 MyLight</b>	A <sup>+</sup>	bianco	2640071ML-10	947,00
		giallo	2640071ML-55	
		grafite	2640071ML-22	1.016,00
		rame	2640071ML-80	
<b>Spokes 1 MyLight h. 10 m •</b>	A <sup>+</sup>	bianco	2640071ML1010	1.012,00
		giallo	2640071ML1055	
		grafite	2640071ML1022	1.081,00
		rame	2640071ML1080	
<b>Spokes 2 MyLight</b>	A <sup>+</sup>	bianco	2640072ML-10	932,00
		giallo	2640072ML-55	
		grafite	2640072ML-22	1.000,00
		rame	2640072ML-80	
<b>Spokes 2 MyLight h. 10 m •</b>	A <sup>+</sup>	bianco	2640072ML1010	997,00
		giallo	2640072ML1055	
		grafite	2640072ML1022	1.065,00
		rame	2640072ML1080	
<b>Spokes 2 large MyLight</b>	A <sup>+</sup>	bianco	2640172ML-10	1.371,00
		giallo	2640172ML-55	
		grafite	2640172ML-22	1.463,00
		rame	2640172ML-80	
<b>Spokes 2 large MyLight h. 10 m •</b>	A <sup>+</sup>	bianco	2640172ML1010	1.421,00
		giallo	2640172ML1055	
		grafite	2640172ML1022	1.513,00
		rame	2640172ML1080	

Colours: bianco, giallo, grafite, rame



Weight:  
Spokes 1  
net kg 4,40

Spokes 2  
net kg 4,40

Spokes 2 Large  
net kg 6,00

• **On demand:**  
lead times to be checked  
with the sales department

MyLight collection  
→ specifiche p. 184

Tecnico — 2019

Spokes 1



Spokes 2

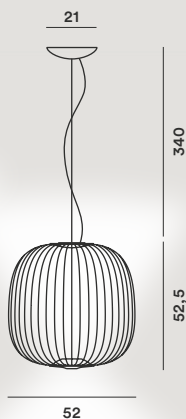

Spokes 2 large

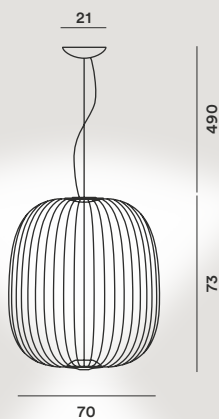

# Supernova

Ferruccio Laviani, 2000



Lacquered or natural aluminium

Max1x150W E27

White globe bulb recommended  
Ø 12 cm

Ⓜ CE IP 20

	energy cl.	colours	code	€ vat excluded
<i>Supernova</i>	A <sup>+</sup> , A	alluminio	102007/3-20	1.168,00
		fucsia	102007/3-66	
<i>Supernova XL</i> ●		alluminio	102007SP7 20	5.485,00
		fucsia	102007SP7 66	

**Accessories:**

<i>Decentralization kit</i> for steel cables	KIT DEC B	28,00
for steel cables + canopy	KIT DEC F	49,00
canopy for electrical dec.	KIT DEC M	87,00

Colours: alluminio, fucsia



Weight:  
*Supernova*  
net kg 8,00

*Supernova XL*  
net kg 19,50

Light bulbs not included  
→ specifications p. 186

Decentralization  
→ specifications p. 124

●  
**On demand:**  
lead times to be checked  
with the sales department

Supernova

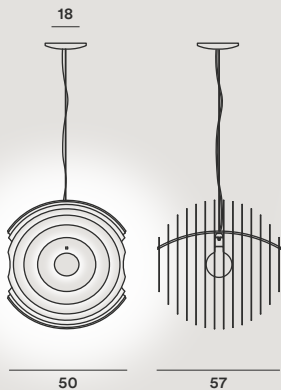

Supernova XL

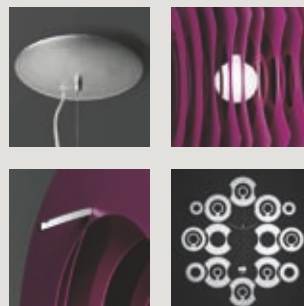
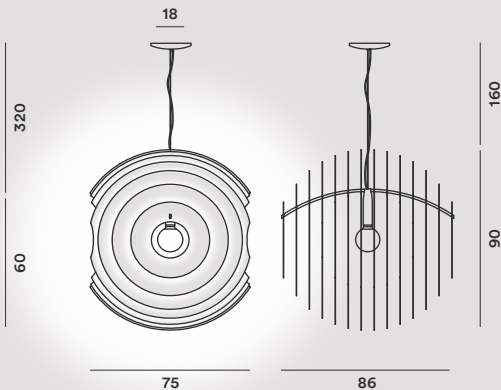

**Tartan**

Ludovica + Roberto  
Palomba, 2015



Blown acid-etched glass  
with reliefs

*Tartan*  
LED retrofit included  
21W E27 2700 K  
2500 lm CRI > 80  
Dimmable with  
TRIAC technology

*Tartan LED*  
included 24W COB  
2700 K 2581 lm CRI>90  
Dimmable version  
Possible configurations:  
On-Off/Push/DALI



	energy cl.	colours	code	€ vat excluded
<i>Tartan</i>	A+, A	bianco	273007E-10	444,00
		grigio	273007E-24	
<i>Tartan LED</i>	A+	bianco	273007L 10	495,00
		grigio	273007L 24	
<i>Tartan LED dimmable</i>	A+	bianco	273007LD 10	551,00
		grigio	273007LD 24	
<i>Tartan h. 10 m •</i>	A+, A	bianco	273007E10-10	489,00
		grigio	273007E24-10	
<i>Tartan LED h. 10 m •</i>	A+	bianco	273007L/10-10	537,00
		grigio	273007L/10-24	
<i>Tartan LED dimmable</i>	A+	bianco	273007LD/1010	593,00
<i>10 m •</i>		grigio	273007LD/1024	

**Spare parts:**

<i>lampshade Tartan</i>	bianco	273S00E-10	244,00
	grigio	273S00E-24	
<i>lampshade Tartan LED</i>	bianco	273S00 10	238,00
	grigio	273S00 24	

**Accessories:**

<i>Decentralization kit</i> for steel cables		KIT DEC B	28,00
	for steel cables + canopy	KIT DEC F	49,00
	canopy for electrical dec.	KIT DEC M	87,00

Colours: bianco, grigio



Weight  
*Tartan*  
net kg 4,60

*Tartan LED*  
net kg 5,20

Multiple canopy  
→ specifications p. 116

Decentralization  
→ specifications p. 124

LED and dimming,  
→ specifications p. 185

•  
**On demand:**  
lead times to be  
checked with the  
sales department

Tecnico — 2019

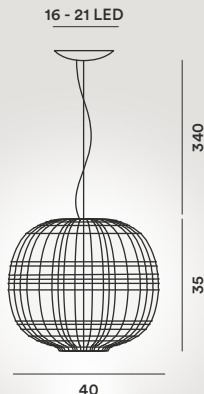

## Tite

Marc Sadler, 2000



Fiberglass fabric with carbonium thread and nickel-plated steel

Max 1x116W E27

⊕ CE IP 20

	energy cl.	colours	code	€ vat excluded
<i>Tite 1</i>	A <sup>+</sup> , A	nero	111017 20	500,00
<i>Tite 2</i>	A <sup>+</sup> , A	nero	111027 20	390,00
<i>Tite 1 h. 10 m •</i>	A <sup>+</sup> , A	nero	111017/10-20	556,00
<i>Tite 2 h. 10 m •</i>	A <sup>+</sup> , A	nero	111027/10-20	445,00

### Spare parts:

<i>Lampshade Tite 1</i>	nero	111S001 20	350,00
<i>Lampshade Tite 2</i>	nero	111S002 20	250,00

### Accessories:

<i>Decentralization kit</i> for power cable		KIT DEC C	33,00
	canopy for electrical dec.	KIT DEC M	87,00

Colours: nero



Weight:

*Tite 1*  
net kg 1,40

*Tite 2*  
net kg 1,00

•

**On demand:**  
lead times to be checked with the sales department

Light bulbs not included  
→ specifications p. 186

Multiple canopy  
→ specifications p. 116

Decentralization  
→ specifications p. 124

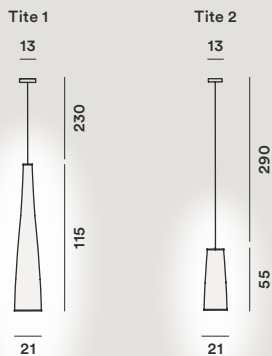

collection →

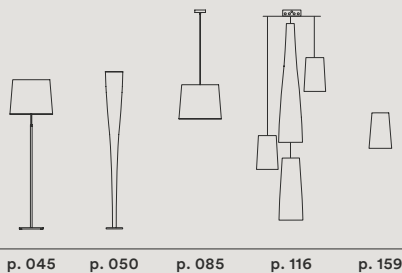

p. 045

p. 050

p. 085

p. 116

p. 159

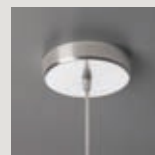

**Tress**

Marc Sadler, 2009



Coated fibreglass-based composite material and chromed metal

*Tress media* or *Tress piccola*  
Max 1x100W E27 PAR 30

*Tress mini*  
Max 1x75W GU10 PAR 20



	energy cl.	colours	code	€ vat excluded
<i>Tress media</i>	A <sup>+</sup> , A	bianco	182017 10	686,00
		nero	182017 20	
		cremisi	182017 67	
		greige	182017 25	
		indaco	182017 87	
<i>Tress piccola</i>	A <sup>+</sup> , A	bianco	182027 10	497,00
		nero	182027 20	
		cremisi	182027 67	
		greige	182027 25	
		indaco	182027 87	
<i>Tress mini</i>	A <sup>+</sup> , A, C	bianco	182037 10	424,00
		nero	182037 20	
		cremisi	182037 67	
		greige	182037 25	
		indaco	182037 87	

Colours: bianco, nero, cremisi, greige, indaco

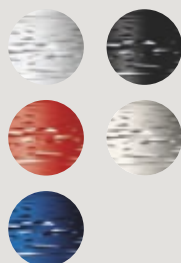

Weight:  
*Tress media*  
net kg 2,40

*Tress piccola*  
net kg 1,60

*Tress mini*  
net kg 1,10

Light bulbs not included  
→ specifications p. 186

Multiple canopy  
→ specifications p. 116

Decentralization  
→ specifications p. 124

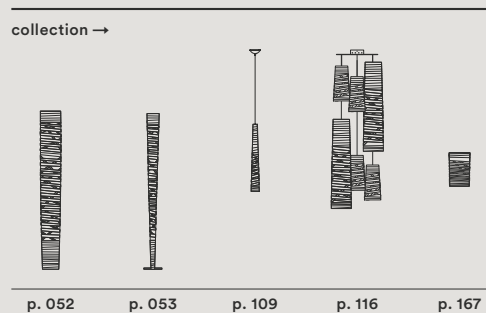
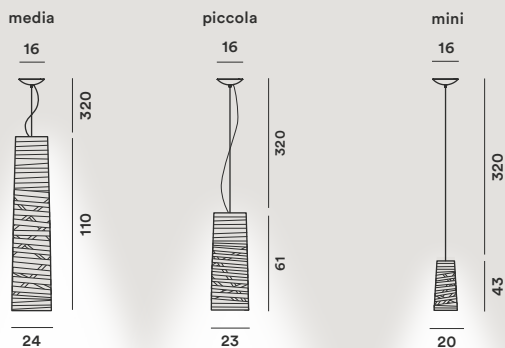



	energy cl.	colours	code	€ vat excluded
<b>Tress media h. 10 m •</b>	A <sup>+</sup> , A	bianco	182017/10-10	<b>740,00</b>
		nero	182017/10-20	
		cremisi	182017/10-67	
		greige	182017/10-25	
		indaco	182017/10-87	
<b>Tress piccola h. 10 m •</b>	A <sup>+</sup> , A	bianco	182027/10-10	<b>551,00</b>
		nero	182027/10-20	
		cremisi	182027/10-67	
		greige	182027/10-25	
		indaco	182027/10-87	
<b>Tress mini h. 10 m •</b>	A <sup>+</sup> , A, C	bianco	182037/10-10	<b>478,00</b>
		nero	182037/10-20	
		cremisi	182037/10-67	
		greige	182037/10-25	
		indaco	182037/10-87	

**Spare parts:**

<b>Lampshade Tress media</b>	bianco	182S02 10	<b>501,00</b>
	nero	182S02 20	
	cremisi	182S02 67	
	greige	182S02 25	
	indaco	182S02 87	
<b>Lampshade Tress piccola</b>	bianco	182S01 10	<b>312,00</b>
	nero	182S01 20	
	cremisi	182S01 67	
	greige	182S01 25	
	indaco	182S01 87	
<b>Lampshade Tress mini</b>	bianco	182S0012 10	<b>288,00</b>
	nero	182S0012 20	
	cremisi	182S0012 67	
	greige	182S0012 25	
	indaco	182S0012 87	

**Accessories:**

<b>Decentralization kit</b>	for steel cables	KIT DEC B	<b>28,00</b>
	for steel cables + canopy	KIT DEC F	<b>49,00</b>
	for power cable	KIT DEC C	<b>33,00</b>
	canopy for electrical dec.	KIT DEC M	<b>87,00</b>

•  
**On demand:**  
 lead times to be checked  
 with the sales department

media/piccola



mini



**Tress grande**

Marc Sadler, 2009



Coated fibreglass-based composite material, blown glass, chromed metal and aluminium

*Tress grande LED* included  
35W Mid power 3000 K  
3062 lm CRI>90

Dimmable version  
Possible configurations:  
On-Off/Push/DALI

*Tress grande*  
Max 1x160W R7s



• On demand:  
lead times to be checked  
with the sales department

	energy cl.	colours	code	€ vat excluded
<i>Tress grande LED</i>	A <sup>+</sup>	bianco	182007L 10	1.230,00
		nero	182007L 20	
		cremisi	182007L 67	
		greige	182007L 25	
		indaco	182007L 87	
<i>Tress grande LED dimmable</i>	A <sup>+</sup>	bianco	182007LD 10	1.298,00
		nero	182007LD 20	
		cremisi	182007LD 67	
		greige	182007LD 25	
		indaco	182007LD 87	
<i>Tress grande</i>	A <sup>+</sup>	bianco	182007 10	808,00
		nero	182007 20	
		cremisi	182007 67	
		greige	182007 25	
		indaco	182007 87	
<i>Tress grande LED h. 10 m •</i>	A <sup>+</sup>	bianco	182007L/10-10	1.345,00
		nero	182007L/10-20	
		cremisi	182007L/10-67	
		greige	182007L/10-25	
		indaco	182007L/10-87	
<i>Tress grande LED dimmable h. 10 m •</i>	A <sup>+</sup>	bianco	182007LD/1010	1.413,00
		nero	182007LD/1020	
		cremisi	182007LD/1067	
		greige	182007LD/1025	
		indaco	182007LD/1087	
<i>Tress grande h. 10 m •</i>	A <sup>+</sup>	bianco	182007/10-10	923,00
		nero	182007/10-20	
		cremisi	182007/10-67	
		greige	182007/10-25	
		indaco	182007/10-87	
<b>Spare parts:</b>				
<i>Lampshade Tress grande</i>		bianco	182S04 10	471,00
		nero	182S04 20	
		cremisi	182S04 67	
		greige	182S04 25	
		indaco	182S04 87	
<b>Accessories:</b>				
<i>Decentralization kit</i> for steel cables			KIT DEC B	28,00

Colours: bianco, nero, cremisi, greige, indaco

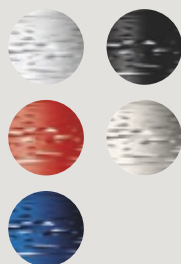

Weight:  
LED net kg 4,90

Halogen net kg 3,10

Light bulbs not included  
→ specifications p. 186

Decentralization → specifications p. 124

LED and dimming, → specifications p. 185

Tecnico — 2019

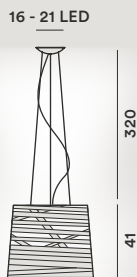

collection →

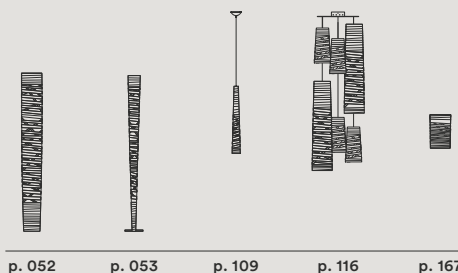

p. 052 p. 053 p. 109 p. 116 p. 167

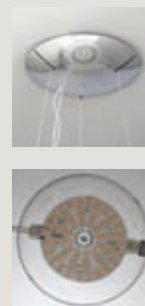

**Tress Stilo**

Marc Sadler, 2011



Coated fibreglass-based composite material and stainless steel

Max 1x35W GU10 PAR 16

⊕ CE IP 20

	energy cl.	colours	code	€ vat excluded
<i>Tress Stilo</i>	A+, A, C	bianco	182047R1-10	338,00
		nero	182047R1-20	
<i>Tress Stilo h. 10 m •</i>	A+, A, C	bianco	182047R1/1010	394,00
		nero	182047R1/1020	

**Accessories:**

<i>Decentralization kit</i> for power cable	KIT DEC C	33,00
canopy for electrical dec.	KIT DEC M	87,00

Colours: bianco, nero



Weight:  
net kg 0,50

•  
**On demand:**  
lead times to be  
checked with the  
sales department

Light bulbs not included  
→ specifications p. 186

Multiple canopy  
→ specifications p. 116

Decentralization  
→ specifications p. 124



7

collection →

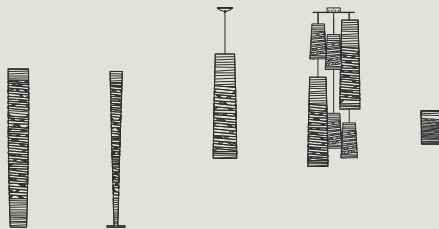

p. 052

p. 053

p. 106/108

p. 116

p. 167



**Troag**

Luca Nichetto, 2010



Curved plywood and PMMA

*Troag grande*  
Fluo 1x80W G5

*Troag media*  
Fluo 1x54W G5

*Troag piccola*  
Fluo 1x24W G5

On request dimmable version  
Possible configurations:  
On-Off/Push/DALI

⊕ CE IP 20

	energy cl.	colours	code	€ vat excluded
<i>Troag grande</i>	A <sup>+</sup> , A	bianco	2050071 10	917,00
		nero	2050071 20	
		naturale	2050071 50	
<i>Troag media</i>	A <sup>+</sup> , A	bianco	205007/3-10	754,00
		nero	205007/3-20	
		naturale	205007/3-50	
<i>Troag piccola</i>	A <sup>+</sup> , A	bianco	2050072/3-10	648,00
		nero	2050072/3-20	
		naturale	2050072/3-50	
<i>Troag grande h. 10 m •</i>	A <sup>+</sup> , A	bianco	2050071SP1010	969,00
		nero	2050071SP1020	
		naturale	2050071SP1050	
<i>Troag media h. 10 m •</i>	A <sup>+</sup> , A	bianco	205007SP10 10	821,00
		nero	205007SP10 20	
		naturale	205007SP10 50	
<i>Troag piccola h. 10 m •</i>	A <sup>+</sup> , A	bianco	2050072SP1010	715,00
		nero	2050072SP1020	
		naturale	2050072SP1050	

Accessories:

<i>Decentralization kit</i> canopy for electrical dec.	KIT DEC M	87,00
--	-----------	-------

Colours: bianco, nero, naturale

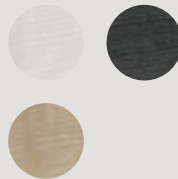

Weight:

*Troag grande*  
net kg 3,50

*Troag media*  
net kg 2,80

*Troag piccola*  
net kg 1,80

Light bulbs not included  
→ specifications p. 186

Decentralization  
→ specifications p. 124

LED and dimming,  
→ specifications p. 185

•  
**On demand:**  
lead times to be checked with the sales department

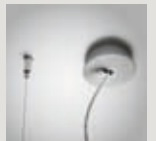
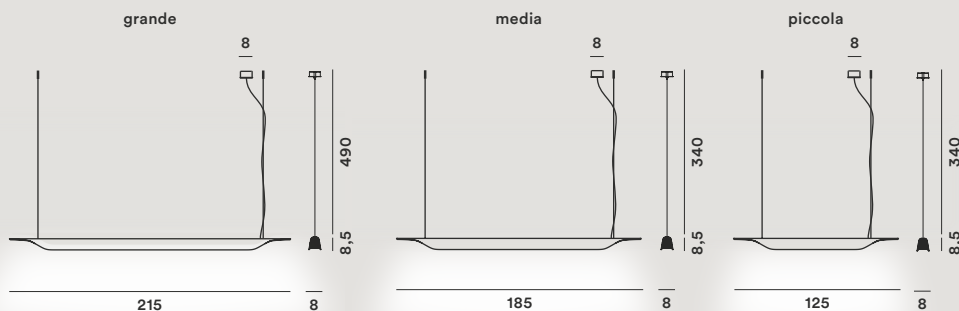

**Twiggy**

Marc Sadler, 2007



Coated fibreglass-based composite material, PMMA, and polycarbonate

Max 3x77W E27

⊕ CE IP 20

	energy cl.	colours	code	€ vat excluded
<i>Twiggy grande</i>	A <sup>+</sup> , A	bianco	159007 10	701,00
		nero	159007 20	
<i>Twiggy grande h. 10 m</i> •	A <sup>+</sup> , A	bianco	159007/10-10	719,00
		nero	159007/10-20	

**Spare parts:**

<i>Lampshade Twiggy grande</i>	bianco	159S10 10	473,00
	nero	159S10 20	
<i>Lower diffusor disk</i>		159R05	33,00

**Accessories:**

<i>Decentralization kit</i> for power cable		KIT DEC C	33,00
	canopy for electrical dec.	KIT DEC M	87,00

Colours: bianco, nero



Weight:  
net kg 1,80

Light bulbs not included  
→ specifications p. 186

Decentralization  
→ specifications p. 124

•  
**On demand:**  
lead times to be  
checked with the  
sales department

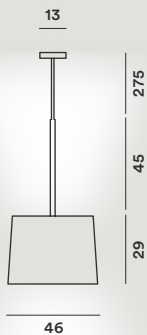

collection →

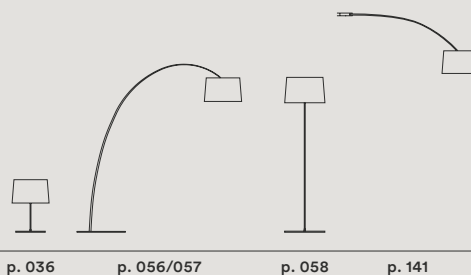





**Twice as Twiggy**

Marc Sadler, 2016



Coated fibreglass-based composite material, coated metal, PMMA and and aluminium

LED included  
81W (54 + 27 Mid-power)  
3000 K 8517 lm CRI>90  
Dimmable  
Possible configurations:  
On-Off/Push/DALI

⊕ CE IP 20

	energy cl.	colours	code	€ vat excluded
<i>Twice as Twiggy</i>	A <sup>+</sup>	bianco	275017 10	2.443,00
		nero	275017 20	
		greige	275017 25	
		cremisi	275017 67	
		indaco	275017 87	
<i>Twice as Twiggy h. 10 m</i> • A <sup>+</sup>	A <sup>+</sup>	bianco	275017/10-10	2.457,00
		nero	275017/10-20	
		greige	275017/10-25	
		cremisi	275017/10-67	
		indaco	275017/10-87	

**Spare parts:**

<i>Lampshade Twice as Twiggy</i>	bianco	275S001 10	1.956,00
	nero	275S001 20	
	greige	275S001 25	
	cremisi	275S001 67	
	indaco	275S001 87	

Colours: bianco, nero, cremisi, greige, indaco

Weight: net kg 8,40

LED and dimming, → specifications p. 185



• **On demand:**  
lead times to be checked with the sales department

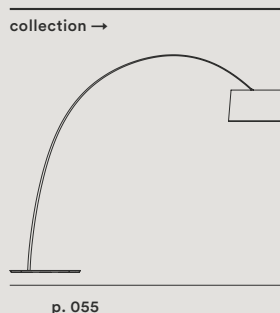
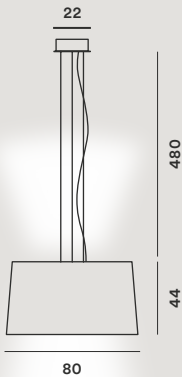

**Uto**

Lagranja Design, 2005



	energy cl.	colours	code	€ vat excluded
<b>Uto</b>	A <sup>+</sup> , A	bianco	142000 10	356,00
		giallo	142000 50	
		arancio	142000 53	

Thermoplastic elastomer and polycarbonate

Max 1x12W E27  
Switch inside the flexible tube

CE IP 20

Colours: bianco, giallo, arancio



Weight:  
net kg 2,00

Light bulbs not included  
→ specifications p. 186

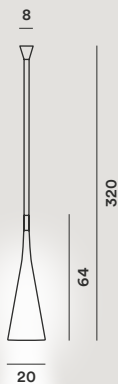

collection →

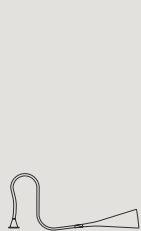

p. 037

p. 182

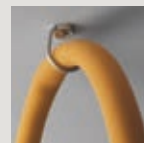



*Accessori, Accessories*

116 **Rosone multiplo tondo**

116 **Rosone multiplo lineare**

124 **Kit decentramento**

## Multiple canopies



### Round multiple canopy

Colour: white  
Laquered metal

Weight: net kg 9,00

⊕ CE  IP 20

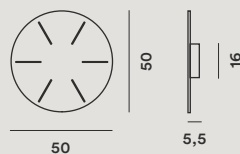

code: ROSONE01 10

€ vat excluded  
419,00

Max 30 kg



### Linear multiple canopy 90 cm

Colour: white  
Laquered metal

Weight: net kg 7,00

⊕ CE  IP 20

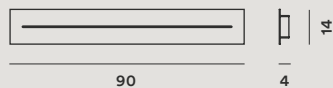

code: ROSONE02 10

€ vat excluded  
352,00

Max 30 kg



## Linear multiple canopy 135 cm

Colour: white  
Laquered metal

Weight: net kg 10,00

⊕ CE  IP 20

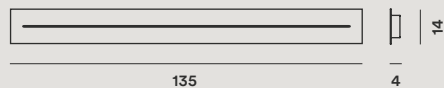

code: ROSONE03 10

€ vat excluded  
469,00

Max 30 kg

Max refers  
to installation  
in staggered  
composition

Model	round	linear 90	linear 135
<i>Aplomb - Aplomb mini</i>	max 9	max 6	max 9
<i>Arumi</i>	max 9	max 6	max 9
<i>Birdie grande</i>	max 6	max 6	max 9
<i>Birdie piccola</i>	max 9	max 6	max 9
<i>Buds 1 ▲</i>	max 6	max 6	max 9
<i>Buds 2 ▲</i>	max 6	max 4	max 6
<i>Buds 3 ▲</i>	max 6	max 5	max 8
<i>Caboche piccola</i>	max 6	max 5	max 8
<i>Caiigo</i>	max 6	max 6	max 9
<i>Chouchin / reverse 1 ▲</i>	max 6	max 4	max 6
<i>Chouchin / reverse 2 ▲</i>	max 6	max 6	max 9
<i>Chouchin / reverse 3 ▲</i>	max 6	max 5	max 8
<i>Chouchin mini 1 - 2</i>	max 9	max 6	max 9
<i>Gem ▲</i>	max 5	max 4	max 5
<i>Gregg grande ▲</i>	max 5	max 4	max 5
<i>Gregg media ▲</i>	max 6	max 5	max 5
<i>Gregg MIDI</i>	max 6	max 6	max 6
<i>Gregg piccola</i>	max 9	max 6	max 9
<i>Havana</i>	max 6	max 6	max 9
<i>Maki</i>	max 9	max 6	max 9
<i>Plass media</i>	max 6	max 5	max 8
<i>Rituals 1</i>	max 6	max 6	max 9
<i>Rituals 2</i>	max 6	max 5	max 7
<i>Rituals 3</i>	max 9	max 6	max 9
<i>Rituals XL ▲</i>	max 5	max 4	max 5
<i>Satellight</i>	max 6	max 5	max 6
<i>Tartan ▲</i>	max 5	max 4	max 5
<i>Tite 1 - Tite 2</i>	max 9	max 6	max 9
<i>Tress media - Tress piccola</i>	max 6	max 6	max 9
<i>Tress mini - Tress Stilo</i>	max 9	max 6	max 9

▲ excluded integrated LED version

Round multiple canopy

Aplomb + Aplomb mini



Arumi

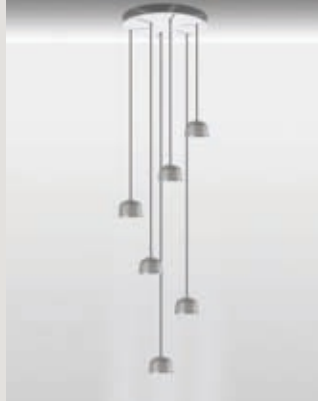

Birdie



Buds



Caboche piccola

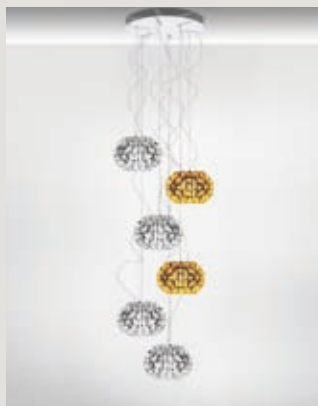

Chouchin + Chouchin mini



## Round multiple canopy

Gem



Gergg grande + media + MIDI



Gregg MIDI



Havana



Maki



Plass media

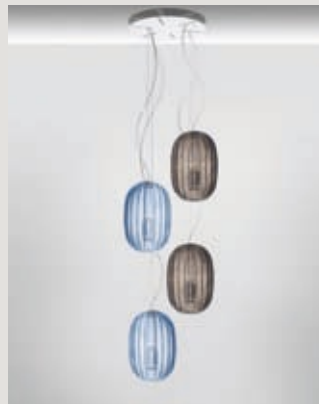

Round multiple canopy

Rituals XL



Tartan



Tite 1



Tite 2



Tress



Tress stilo



## Linear multiple canopy

Aplomb + Aplomb mini



Birdie



Caboche piccola

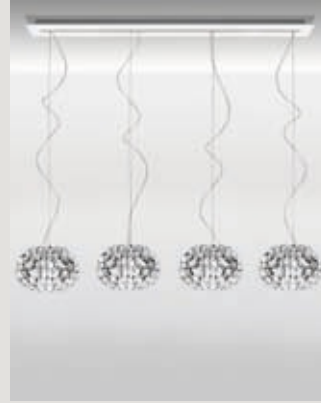

Couchin



Couchin reverse



Gem

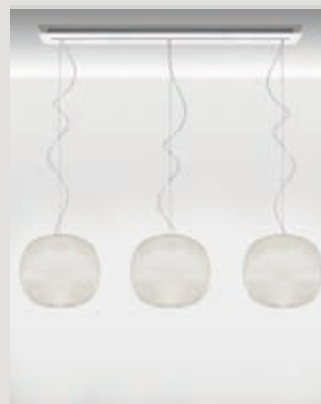

Linear multiple canopy

Rituals XL



Plass media



Satellite



Tartan



Tite 2



Tress

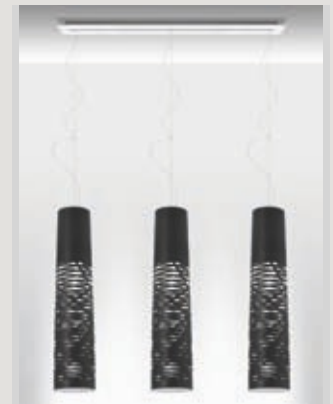



## Linear multiple canopy

Rituals



Gregg piccola



Gregg MIDI



Maki



# Decentralization kit



## Kit B — Code: KIT DEC B

Decentralization kit, includes 3 supports for steel cables.

For the models: Allegretto, Allegro, Behive, Big Bang, Buds, Caboche, Caiigo, Chouchin, Chouchin Reverse, Chouchin mini, Gem, Gregg grande/media, Lightweight, Le Soleil, New Buds, O-Space, Plass, Plass media, Rituals, Rituals XL, Satelight, Spokes, Supernova, Tartan, Twice as Twiggy, Tress grande /media /piccola.

Weight: net kg 0,01

€ vat excluded
28,00



## Kit C — Code: KIT DEC C

Decentralization for power cable.

For the models: Aplomb, Aplomb large, Aplomb mini, Birdie, Giga-Lite, Gregg piccola, Havana, Maki, Tite, Tress mini, Tress stilo, Twiggy

Weight: net kg 0,01

€ vat excluded
33,00





### Kit F — Code: KIT DEC F



Decentralization kit, includes 3 supports for steel cables + spare canopy.

For the models: Allegretto, Allegro, Behive, Big Bang ▲, Buds ▲, Caboche ▲, Chouchin / reverse ▲, Chouchin mini, Gem, Gregg grande /media ▲, Le Soleil, O-Space, Plass ▲, Plass media, Rituals, Rituals xl ▲, Satellight, Supernova, Tartan ▲, Tress grande ▲ /media / piccola.

▲ LED version excluded

Weight: net kg 0,03

€ vat excluded

49,00

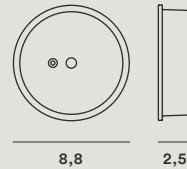

### Kit M — Code: KIT DEC M



Canopy electrical decentralization up to 4 lamps.

The kit M contains only the canopy, to compositions as picture order the necessary quantity of Kit B or Kit C.

For the models: Aplomb, Aplomb mini, Arumi, Behive, Big Bang ▲, Birdie, Buds ▲, Caboche ▲, Chouchin / reverse ▲, Chouchin mini, Gem, Giga-Lite, Gregg ▲, Havana, Le Soleil, Maki, O-Space, Plass ▲, Plass media, Rituals, Rituals XL ▲, Satellight, Supernova, Tartan ▲, Tite, Tress ▲, Tress Stilo, Troag, Twiggy.

▲ LED version excluded

Weight: net kg 0,01

€ vat excluded

87,00

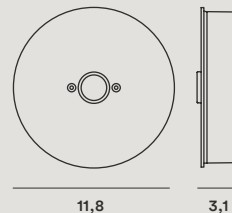



*Soffitto, Ceiling*

- |     |                               |     |                   |
|-----|-------------------------------|-----|-------------------|
| 128 | <b>Bahia +<br/>Bahia mini</b> | 135 | <b>Folio</b>      |
| 129 | <b>Big Bang</b>               | 136 | <b>Gregg</b>      |
| 130 | <b>Birdie</b>                 | 137 | <b>Lumiere XX</b> |
| 132 | <b>Blob S</b>                 | 138 | <b>Nuage</b>      |
| 133 | <b>Caboche</b>                | 139 | <b>Rituals</b>    |
| 134 | <b>Circus</b>                 | 140 | <b>Superficie</b> |
|     |                               | 141 | <b>Twiggy</b>     |

**Bahia + Bahia mini**

Lucidi e Pevere, 2010-2015

**LED**

	energy cl.	colours	code	€ vat excluded
<i>Bahia fluo</i>	A <sup>+</sup> , A	bianco	196005 10	454,00
<i>Bahia LED</i>	A <sup>+</sup>	bianco	196005L 10	634,00
<i>Bahia LED dimmable</i>	A <sup>+</sup>	bianco	196005LD 10	685,00
<i>Bahia mini fluo</i>	A <sup>+</sup> , A	bianco	1960052 10	253,00
<i>Bahia mini fluo dimmable</i>	A <sup>+</sup> , A	bianco	1960052D 10	317,00
<i>Bahia mini LED</i>	A <sup>+</sup>	bianco	1960052L 10	407,00
<i>Bahia mini LED dimmable</i>	A <sup>+</sup>	bianco	1960052LD 10	459,00

Injection moulded polycarbonate

*Bahia fluo*  
Fluo 1x40W + 1x22W 2GX13

*Bahia LED* included  
43W Mid-power 2850 K  
4850 lm CRI>90  
Dimmable version  
Possible configurations:  
On-Off/Push/DALI

*Bahia mini fluo*  
Fluo 1x22W 2GX13  
Dimmable version  
Possible configurations:  
On-Off/Push/DALI

*Bahia mini LED* included  
21W Mid-power 2850 K  
2425 lm CRI>90  
Dimmable version  
Possible configurations:  
On-Off/Push/DALI

⊕ CE IP 20

Colours: bianco



Weight:  
*Bahia*  
net kg 4,40

*Bahia mini*  
net kg 2,70

Light bulbs not included  
→ specifications p. 186

LED and dimming  
→ specifications p. 185

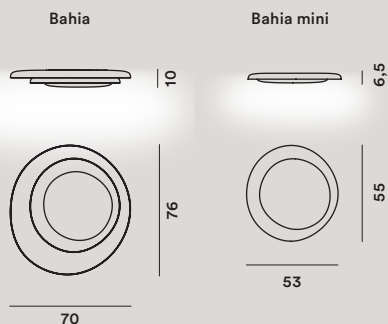

collection →



p. 145

p. 145

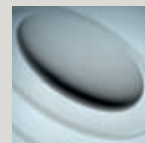
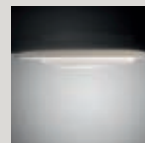

## Big Bang

Enrico Franzolini con  
Vicente Garcia Jimenez, 2005



	energy cl.	colours	code	€ vat excluded
<i>Big Bang</i>	A <sup>+</sup> , A, C	bianco	151005 10	437,00
		rosso	151005 63	454,00

### Spare parts:

<i>Set lampshades Big Bang</i>	bianco	151S05 10	259,00
	rosso	151S05 63	276,00
<i>Halogen protection glass</i>		PIREX94/4/I	21,00

Methacrylate and coated  
metal

Max 1x120W R7s

⊕ CE IP 20

Colours: bianco, rosso

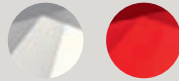

Weight:  
net kg 3,00

Light bulbs not included  
→ specifications p. 186



23

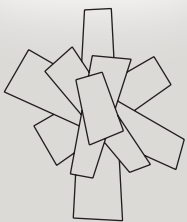

79

66

collection →

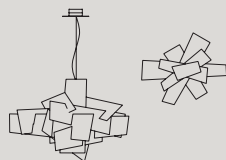

p. 070/071

p. 146

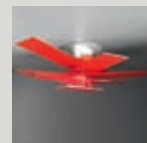

## Birdie

Ludovica + Roberto  
Palomba, 2012



Polycarbonate and coated aluminium

Max 3-6-9x70W E27

Different heights on request



	energy cl.	colours	code	€ vat excluded
<b>Birdie 3</b>	A+, A	bianco	2210083 10	726,00
		grigio	2210083 25	
		arancio	2210083 53	
		amaranto	2210083 65	
<b>Birdie 6</b>	A+, A	bianco	2210086 10	1.365,00
		grigio	2210086 25	
		arancio	2210086 53	
		amaranto	2210086 65	
<b>Birdie 9</b>	A+, A	bianco	2210089 10	2.020,00
		grigio	2210089 25	
		arancio	2210089 53	
		amaranto	2210089 65	

### Spare parts:

<b>Lampshade Birdie</b>	bianco	221S002 10	47,00
	grigio	221S002 25	
	arancio	221S002 53	
	amaranto	221S002 65	

Colours: bianco, grigio, arancio, amaranto

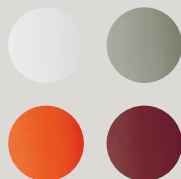

Weight:  
**Birdie 3**  
net kg 3,70

**Birdie 6**  
net kg 6,60

**Birdie 9**  
net kg 9,50

Light bulbs not included  
→ specifications p. 186

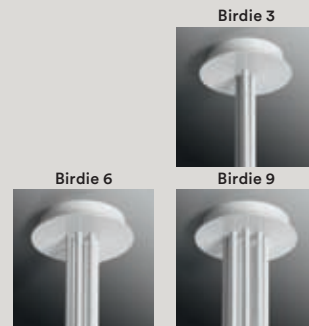
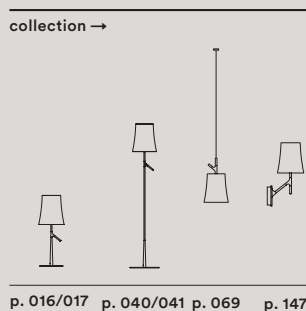
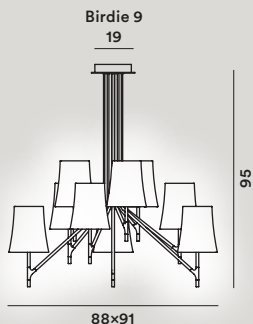
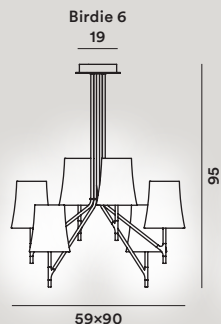
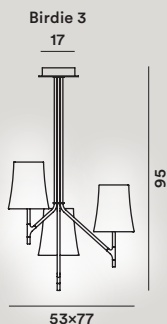



# Birdie

Ludovica + Roberto  
Palomba, 2013



Polycarbonate and coated aluminium

Max 6-9x60W E27

⊕ CE IP 20

	energy cl.	colours	code	€ vat excluded
<i>Birdie 6 with cables</i>	A+, A	bianco	2210076 10	1.589,00
		grigio	2210076 25	
		arancio	2210076 53	
		amaranto	2210076 65	
<i>Birdie 9 with cables</i>	A+, A	bianco	2210079 10	2.244,00
		grigio	2210079 25	
		arancio	2210079 53	
		amaranto	2210079 65	
<b>Spare parts:</b>				
<i>Lampshade Birdie</i>		bianco	221S002 10	47,00
		grigio	221S002 25	
		arancio	221S002 53	
		amaranto	221S002 65	

Colours: bianco, grigio, arancio, amaranto



Weight:  
*Birdie 6*  
net kg 6,60

*Birdie 9*  
net kg 9,50

Light bulbs not included  
→ specifications p. 186

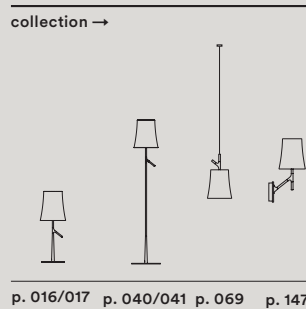
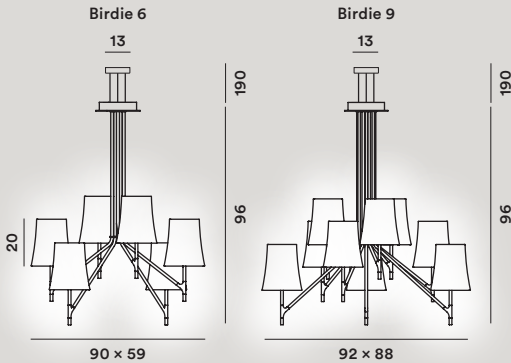

## Blob S

Karim Rashid, 2002



Rotational moulded polyethylene and coated metal

Fluo 1x24W 2G11

☐ CE IP 20

	energy cl.	colours	code	€ vat excluded
<i>Blob S</i>	A <sup>+</sup> , A	bianco	124035 10	188,00
<b>Spare parts:</b>				
<i>Lampshade Blob S</i>		bianco	124S00 10	63,00

Colours: bianco



Weight:  
net kg 1,10

Light bulbs not included  
→ specifications p. 186

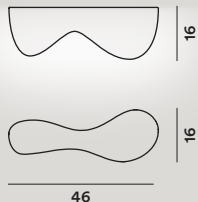

collection →



## Caboche

Patricia Urquiola con  
Elia Gerotto, 2006



PMMA, blown glass and  
chromed metal

Max 1x120W R7s

⊕ CE IP 20

	energy cl.	colours	code	€ vat excluded
<i>Caboche</i>	A <sup>+</sup> , A, C	trasparente	138008 16	781,00
		giallo oro	138008 52	
<b>Spare parts:</b>				
<i>Kit 10 spheres Caboche</i>		trasparente	138KIT 10SF16	40,00
		giallo oro	138KIT 10SF52	
<i>Kit 15 prongs 3 spheres Caboche</i>			138KIT 15M3	30,00
<i>Kit 15 prongs 4 spheres Caboche</i>			138KIT 15S4	30,00
<i>Kit 3+3 prongs 3-4 spheres Caboche</i>			138KIT3-R2	18,00
<i>Glass Caboche</i>			138V018/1	93,00
<i>Halogen protection glass</i>			PIREX138/2S4I	21,00

Colours: trasparente,  
giallo oro

Weight:  
net kg 9,10

Light bulbs not included  
→ specifications p. 186

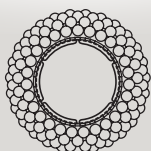
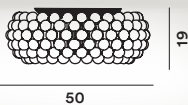
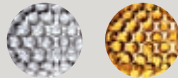

collection →

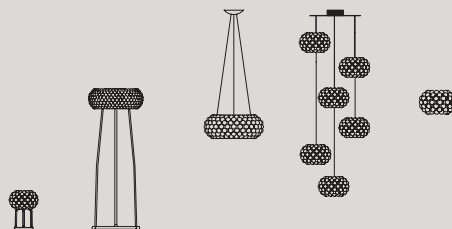

p. 020

p. 042

p. 074/077

p. 116

p. 150



**Circus**

Defne Koz, 1994

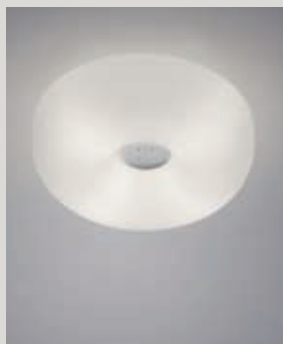

	energy cl.	colours	code	€ vat excluded
<i>Circus grande</i>	A <sup>+</sup> , A, B, C	bianco	0460081 11	428,00
<i>Circus piccola</i>	A <sup>+</sup> , A, B, C	bianco	046008 11	272,00

**Spare parts:**

<i>Glass Circus grande</i>	bianco	046S001 11	275,00
<i>Glass Circus piccola</i>	bianco	046S00 11	153,00

Blown glass, nickel-plated or coated metal

*Circus grande*  
Max 4x46W E27

*Circus piccola*  
Max 4x30W E14

⊕ CE IP 20

Colours: bianco



Weight:  
*Circus grande*  
net kg 4,70

*Circus piccola*  
net kg 2,10

Light bulbs not included  
→ specifications p. 186

grande



46

piccola



32

collection →



p. 151



## Folio

Carlo Urbinati e Alessandro Vecchiato, 1990



Blown acid-etched glass and coated metal

Max 1x120W R7s

⊕ CE IP 20

	energy cl.	colours	code	€ vat excluded
<i>Folio grande</i>	A <sup>+</sup> , A, C	bianco	019008 10	366,00
<b>Spare parts:</b>				
<i>Glass Folio grande</i>		bianco	019S001 10	215,00
<i>Halogen protection glass</i>			PIREX94/4/1	21,00

Colours: bianco



Weight:  
net kg 2,20

Light bulbs not included  
→ specifications p. 186

collection →



48



p. 155



**Gregg**

Ludovica e Roberto  
Palomba, 2007



	energy cl.	colours	code	€ vat excluded
<i>Gregg media</i>	A <sup>+</sup> , A	bianco	168005 10	313,00
<i>Gregg MIDI</i>	A	bianco	1680053-10	237,00
<i>Gregg piccola</i>	A <sup>+</sup> , A, C	bianco	1680052 10	147,00

Spare parts:				
<i>Glass Gregg media</i>		bianco	168S00 10	180,00
<i>Glass Gregg MIDI</i>		bianco	168S003-10	91,00
<i>Glass Gregg piccola</i>		bianco	168S00210	60,00

Blown acid-etched and white lacquered metal

Colours: bianco

Weight:  
*Gregg media*  
net kg 2,90

Light bulbs not included  
→ specifications p. 186

*Gregg media*  
Max 1x150W E27



*Gregg MIDI*  
netto kg 1,60

*Gregg MIDI*  
LED included COB 8,5W  
2700 K 830 lm CRI>80  
Dimmable with  
TRIAC technology



*Gregg piccola*  
net kg 0,60

*Gregg piccola*  
Max 1x20W G9



media

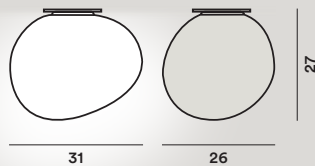

MIDI

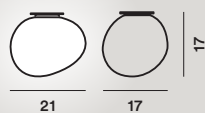

piccola

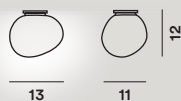

collection →

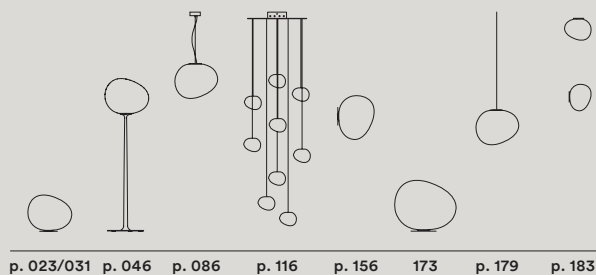

**Lumiere XXL + XXS**

Rodolfo Dordoni, 2010

**LED**

Blown glass and lacquered metal

**Lumiere XXL LED**

LED included  
32W 2700K  
2720 lm CRI>80  
Dimmable with TRIAC technology

**Lumiere XXL fluo**

Fluo 1x40W + 1x22W 2GX13  
Dimmable Fluo 1x55W 2GX13  
Dimmable version  
Possible configurations:  
On-Off/Push/DALI

**Lumiere XXS LED**

LED included  
18W 2700 K  
1521 lm CRI>80  
Dimmable with TRIAC technology

**Lumiere XXS fluo**

Fluo 2x18W G24q-2

⊕ CE IP 20

	energy cl.	colours	code	€ vat excluded
<b>Lumiere XXL LED</b>	A <sup>+</sup>	bianco	191005L-11	374,00
		grigio	191005L-24	416,00
<b>Lumiere XXL fluo *</b>	A <sup>+</sup> , A	bianco	191005 11	365,00
<b>Lumiere XXL fluo dimm. *</b>	A <sup>+</sup> , A	bianco	191005DM 11	438,00
<b>Lumiere XXS LED</b>	A <sup>+</sup>	bianco	1910052L-11	314,00
		grigio	1910052L-24	335,00
<b>Lumiere XXS fluo *</b>	A <sup>+</sup> , A	bianco	1910052 11	312,00
<b>Spare parts:</b>				
<b>Glass Lumiere XXL LED</b>		bianco	191S0051R1-11	205,00
		grigio	191S0051R1-24	247,00
<b>Glass Lumiere XXS LED</b>		bianco	191S0052R1-11	148,00
		grigio	191S0052R1-24	169,00
<b>Glass Lumiere XXL fluo</b>		bianco	191S0051 11	205,00
		grigio	191S0051-24	247,00
<b>Glass Lumiere XXS fluo</b>		bianco	191S0052 11	148,00
		grigio	191S0052-24	169,00

\* Limited stock available

Colours: bianco,  
grigio freddo



Weight:  
**Lumiere XXL**  
net kg 3,40

**Lumiere XXS**  
net kg 1,80

Light bulbs not included  
→ specifications p. 186

LED and dimming  
→ specifications p. 185

Lumiere XXL

Lumiere XXS

collection →

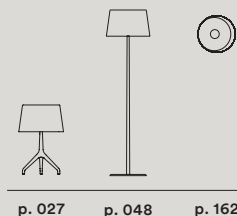
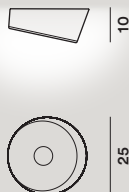
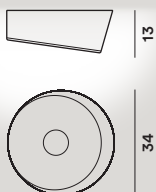

p. 027

p. 048

p. 162



## Nuage

Philippe Nigro, 2012

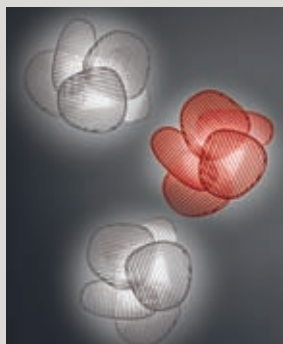

Injection-moulded polycarbonate and batch-dyed ABS

Fluo 1x40W + 1x22W 2GX13 dimmable 1x55W 2GX13  
Dimmable version  
Possible configurations: On-Off/Push/DALI

Usable in composition



	energy cl.	colours	code	€ vat excluded
<b>Nuage</b>	A <sup>+</sup> , A	bianco	243005 10	415,00
		rosso*	243005 63	
<b>Nuage dimmable</b>	A <sup>+</sup> , A	bianco	243005DM 10	469,00
		rosso*	243005DM 63	
<b>Accessories</b>				
<b>Lamp connection kit</b>	40+22W		243KIT	27,00
	dimmable		243KIT DM	41,00
<b>Spare parts:</b>				
<b>Set lampshades Nuage</b>		bianco	243S00 10	286,00
		rosso*	243S00 63	

\* Limited stock available

Colours: bianco,



rosso\*

\* Limited stock available



Weight:  
net kg 3,20

Light bulbs not included  
→ specifications p. 186

LED and dimming  
→ specifications p. 185

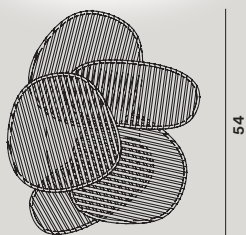
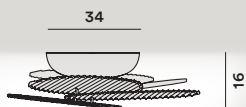

collection →

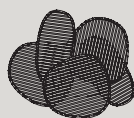

p. 163

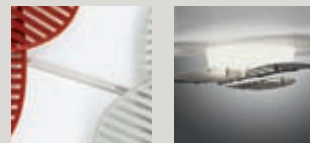



# Rituals

Ludovica e Roberto  
Palomba, 2015



Blown satin glass and  
lacquered metal

Max 1x70W E27

⊕ CE IP 20

	energy cl.	colours	code	€ vat excluded
<i>Rituals 1</i>	A <sup>+</sup> , A	bianco	2440081 10	351,00
<i>Rituals 2</i>	A <sup>+</sup> , A	bianco	2440082 10	351,00
<i>Rituals 3</i>	A <sup>+</sup> , A	bianco	2440083 10	300,00
<b>Spare parts:</b>				
<i>Glass Rituals 1</i>		bianco	244S001 10	226,00
<i>Glass Rituals 2</i>		bianco	244S002 10	226,00
<i>Glass Rituals 3</i>		bianco	244S003 10	170,00

Colours: bianco



Weight:  
*Rituals 1*  
net kg 4,10

*Rituals 2*  
net kg 4,20

*Rituals 3*  
net kg 1,70

Light bulbs not included  
→ specifications p. 186

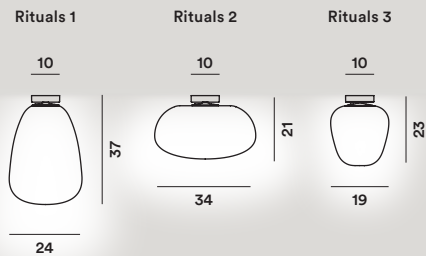

collection →

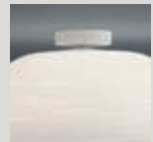
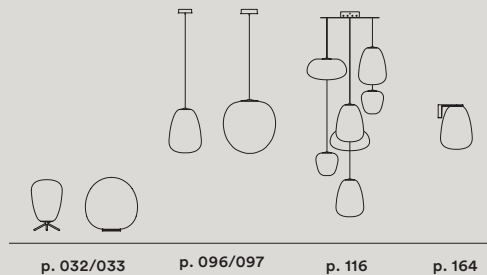

**Superficie**

Calvi & Brambilla, 2017

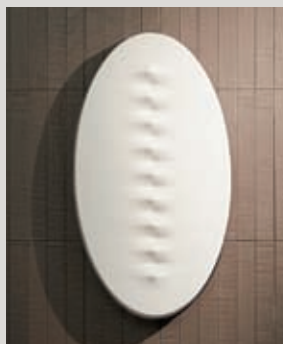

<i>Superficie</i>	energy cl.	colours	code	€ vat excluded
	A <sup>+</sup>	bianco	284005-10	566,00

Thermoformed PMMA and aluminium

LED included  
36 W 2700 K  
3060 lm CRI>80

Dimmable with TRIAC technology

☐ CE ◀ IP 20

Colours: bianco



Weight:  
net kg 2,40

LED and dimming,  
→ specifications p. 185

Tecnico — 2019

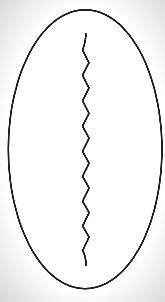

41

75



5

collection →



p. 166

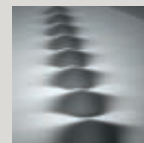

# Twiggy

Marc Sadler, 2007



	energy cl.	colours	code	€ vat excluded
<i>Twiggy</i>	A+, A	bianco	159008 10	959,00
		nero	159008 20	

**Spare parts:**

<i>Lampshade Twiggy</i>	bianco	159S10 10	473,00
	nero	159S10 20	
<i>Lower diffusor disk</i>		159R05	33,00

Compound material on lacquered glass fibre base, PMMA and lacquered metal

Colours: bianco, nero

Weight: net kg 5,60

Light bulbs not included → specifications p. 186



Max 3x77W E27

Rotating 330°  
Stem lenght cannot be changed

⊕ CE IP 20

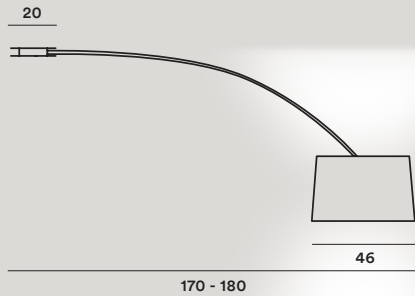

collection →

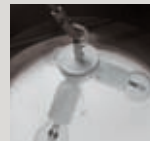
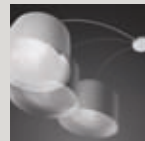
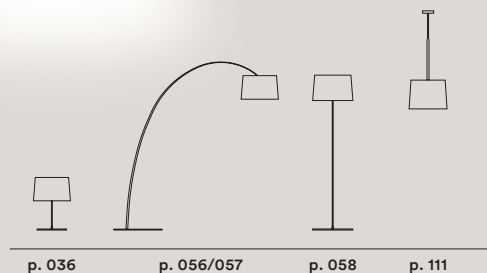
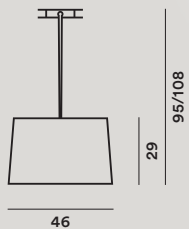



*Parete, Wall*

- |     |                               |     |                   |
|-----|-------------------------------|-----|-------------------|
| 144 | <b>Aplomb</b>                 | 156 | <b>Gregg</b>      |
| 145 | <b>Bahia +<br/>Bahia mini</b> | 157 | <b>Havana</b>     |
| 146 | <b>Big Bang</b>               | 158 | <b>Innerlight</b> |
| 147 | <b>Birdie</b>                 | 159 | <b>Kite</b>       |
| 148 | <b>Bit</b>                    | 160 | <b>Lake</b>       |
| 149 | <b>Blob S</b>                 | 161 | <b>Le Soleil</b>  |
| 150 | <b>Caboche</b>                | 162 | <b>Lumiere XX</b> |
| 151 | <b>Circus</b>                 | 163 | <b>Nuage</b>      |
| 152 | <b>Double</b>                 | 164 | <b>Rituals</b>    |
| 153 | <b>Fields</b>                 | 165 | <b>Satellight</b> |
| 154 | <b>Filo</b>                   | 166 | <b>Superficie</b> |
| 155 | <b>Folio</b>                  | 167 | <b>Tress</b>      |
|     |                               | 168 | <b>Tutù</b>       |

## Aplomb

Lucidi e Pevere, 2014

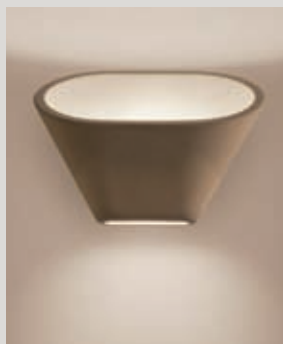

	energy cl.	colours	code	€ vat excluded
<i>Aplomb</i>	A <sup>+</sup>	bianco	195005L 10	437,00
		grigio	195005L 25	
		marrone	195005L 52	

Hand pouring concrete, varnished metal and aluminium

LED included  
13W Acrich 2700 K 1  
120 lmCRI > 80  
Dimmable only with Seoul-Acrich LED compatible modules

⊕ CE IP 20

Colours: bianco, grigio cemento, marrone

Weight: net kg 2,00



Tecnico — 2019



collection →

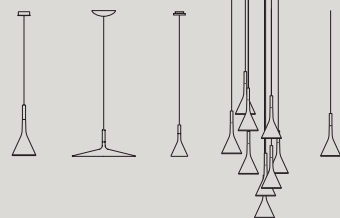

p. 064 p. 065 p. 066 p. 116 p. 178



**Bahia + Bahia mini**

Lucidi e Pevere, 2010-2015

**LED**

	energy cl.	colours	code	€ vat excluded
<i>Bahia fluo</i>	A <sup>+</sup> , A	bianco	196005 10	454,00
<i>Bahia LED</i>	A <sup>+</sup>	bianco	196005L 10	634,00
<i>Bahia LED dimmable</i>	A <sup>+</sup>	bianco	196005LD 10	685,00
<i>Bahia mini fluo</i>	A <sup>+</sup> , A	bianco	1960052 10	253,00
<i>Bahia mini fluo dimmable</i>	A <sup>+</sup> , A	bianco	1960052D 10	317,00
<i>Bahia mini LED</i>	A <sup>+</sup>	bianco	1960052L 10	407,00
<i>Bahia mini LED dimmable</i>	A <sup>+</sup>	bianco	1960052LD 10	459,00

Injection moulded  
polycarbonate

*Bahia fluo*  
Fluo 1x40W + 1x22W 2GX13

*Bahia LED* included  
43W Mid-power 2850 K  
4850 lm CRI>90  
Dimmable version  
Possible configurations:  
On-Off/Push/DALI

*Bahia mini fluo*  
Fluo 1x22W 2GX13  
Dimmable version  
Possible configurations:  
On-Off/Push/DALI

*Bahia mini LED* included  
21W Mid-power 2850 K  
2425 lm CRI>90  
Dimmable version  
Possible configurations:  
On-Off/Push/DALI

⊕ CE IP 20

Colours: bianco



Weight:  
*Bahia*  
net kg 4,40

*Bahia mini*  
net kg 2,70

Light bulbs not included  
→ specifications p. 186

LED and dimming  
→ specifications p. 185

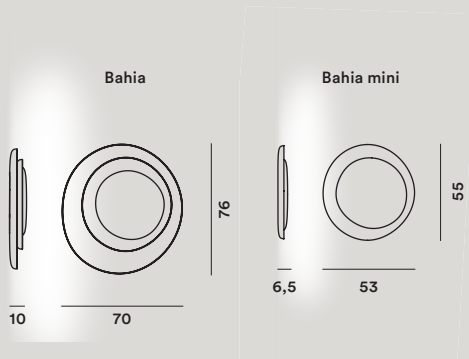

collection →



p. 128

p. 128

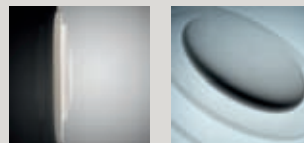

## Big Bang

Enrico Franzolini con Vicente Garcia Jimenez, 2005



	energy cl.	colours	code	€ vat excluded
<i>Big Bang</i>	A <sup>+</sup> , A, C	bianco	151005 10	437,00
		rosso	151005 63	454,00
<b>Spare parts:</b>				
<i>Set lampshades Big Bang</i>		bianco	151S05 10	259,00
		rosso	151S05 63	276,00
<i>Halogen protection glass</i>			PIREX94/4/I	21,00

Methacrylate and lacquered metal

Max 1x120W R7s

⊕ CE IP 20

Colours: bianco, rosso



Weight:  
net kg 3,00

Light bulbs not included  
→ specifications p. 186

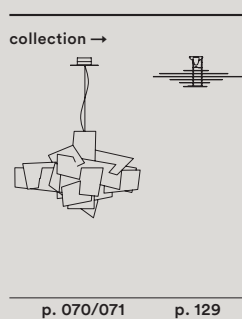
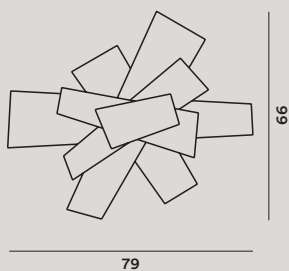



## Birdie

Ludovica + Roberto  
Palomba, 2012



Polycarbonate, coated steel  
and metal

*Birdie*  
Max 1x70W E27

⊕ ⚡ CE IP 20

*Birdie with Integrated touch  
dimmer*

Dimmerable LED retrofit or  
Halo 1x70W E27  
minimum Halo bulb output  
40W

⊕ CE IP 20

	energy cl.	colours	code	€ vat excluded
<i>Birdie</i>	A <sup>+</sup> , A	bianco	2210052 10	218,00
		grigio	2210052 25	
		arancio	2210052 53	
		amaranto	2210052 65	
<i>Birdie with touch dimmer</i>	A <sup>+</sup> , A	bianco	2210052DM 10	270,00
		grigio	2210052DM 25	
		arancio	2210052DM 53	
		amaranto	2210052DM 65	
<b>Spare parts:</b>				
<i>Lampshade Birdie</i>		bianco	221S002 10	47,00
		grigio	221S002 25	
		arancio	221S002 53	
		amaranto	221S002 65	

Colours: bianco, grigio,  
arancio, amaranto

Weight:  
net kg 1,60

Light bulbs not included  
→ specifications p. 186

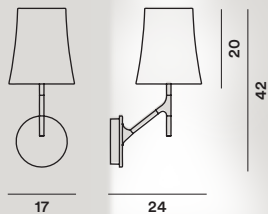

17

24

collection →

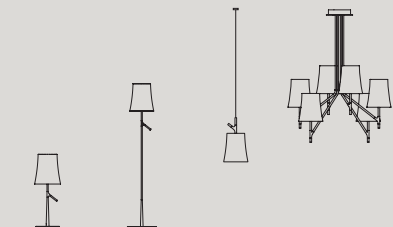

p.016/017

p. 040/041

p. 069

p. 130

**Bit**

Ferruccio Laviani, 1993

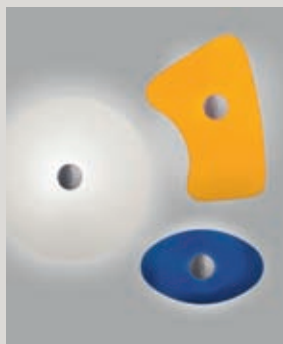

Silkscreen-printed glass and lacquered metal

Max 1x46W E14



	energy cl.	colours	code	€ vat excluded
<b>Bit 1</b>	A <sup>+</sup> , A	rosso	0430051	206,00
		bianco	0430051 10	
<b>Bit 2</b>	A <sup>+</sup> , A	blu	0430052	206,00
		bianco	0430052 10	
<b>Bit 3</b>	A <sup>+</sup> , A	bianco	0430053	206,00
<b>Bit 4</b>	A <sup>+</sup> , A	verde	0430054	206,00
		bianco	0430054 10	
<b>Bit 5</b>	A <sup>+</sup> , A	arancio	0430055	206,00
		bianco	0430055 10	
<b>Spare parts:</b>				
<b>Glass Bit 1</b>		bianco	043S00/1 10	53,00
		rosso	043S00/1 63	
<b>Glass Bit 2</b>		bianco	043S00/2 10	53,00
		blu	043S00/2 33	
<b>Glass Bit 3</b>		bianco	043S00/3 10	53,00
<b>Glass Bit 4</b>		bianco	043S00/4 10	53,00
		verde	043S00/4 40	
<b>Glass Bit 5</b>		bianco	043S00/5 10	53,00
		arancio	043S00/5 52	

Colours: bianco, colorato (1 rosso, 2 blu, 3 bianco, 4 verde, 5 arancio)

Weight:

- Bit 1**  
net kg 1,70
- Bit 2**  
net kg 1,20
- Bit 3**  
net kg 1,80
- Bit 4**  
net kg 1,25
- Bit 5**  
net kg 1,35

Light bulbs not included  
→ specifications p. 186

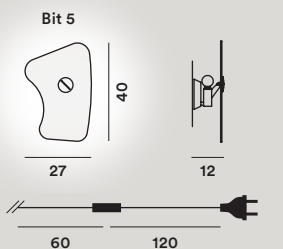
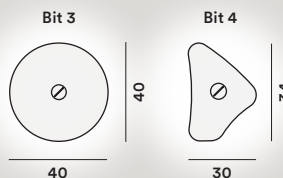
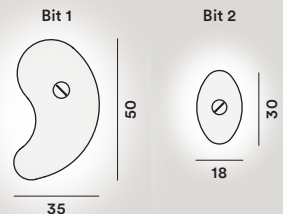

collection →



p. 051

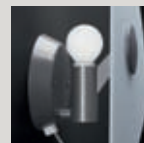

**Blob S**

Karim Rashid, 2002



	energy cl.	colours	code	€ vat excluded
<i>Blob S</i>	A <sup>+</sup> , A	bianco	124035 10	188,00
<b>Spare parts:</b>				
<i>Lampshade Blob S</i>	A <sup>+</sup> , A	bianco	124S00 10	63,00

Rotational moulded  
polyethylene

Fluo 1x24W 2G11

☐ C€ IP 20

Colours: bianco



Weight:  
net kg 1,10

Light bulbs not included  
→ specifications p. 186

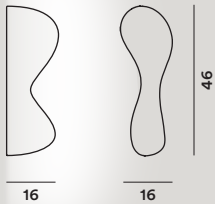

collection →



p. 132



**Caboche**

Patricia Urquiola  
con Eliana Gerotto, 2006



PMMA, blown glass  
and chromed metal and  
aluminium (LED)

*Caboche media LED*  
LED included  
16 W 2700 K 1360 lm CRI>80

*Caboche piccola LED*  
LED included  
12 W 2700 K 1020 lm CRI>80

Dimmable with  
TRIAC technology

*Caboche*  
Max 1x120W R7s



	energy cl.	colours	code	€ vat excluded
<i>Caboche media LED</i>	A <sup>+</sup>	trasparente	138005L-16	641,00
		giallo oro	138005L-52	
<i>Caboche piccola LED</i>	A <sup>+</sup>	trasparente	138025L-16	356,00
		giallo oro	138025L-52	
<i>Caboche media</i>	A <sup>+</sup> , A, C	trasparente	138005 16	590,00
		giallo oro	138005 52	
<i>Caboche piccola</i>	A <sup>+</sup> , A, C	trasparente	138025 16	306,00
		giallo oro	138025 52	

**Spare parts:**

<i>Kit 10 spheres Caboche</i>	trasparente	138KIT 10SF16	40,00
	giallo oro	138KIT 10SF52	
<i>Kit 15 prongs 3 spheres Caboche media</i>		138KIT 15M3	30,00
<i>Kit 15 prongs 4 spheres Caboche media</i>		138KIT 15M4	30,00
<i>Kit 3+3 prongs 3-4 spheres Caboche media</i>		138KIT-R2	21,00
<i>Kit 10 prongs, 3 spheres Caboche piccola</i>		138KIT 10P3	25,00
<i>Kit 10 prongs 4 spheres Caboche piccola</i>		138KIT 10P4	25,00
<i>Kit 3+3 prongs 3-4 spheres Caboche piccola</i>		138KIT2-R2	18,00
<i>Glass Caboche</i>		138V052/1	65,00
<i>Halogen protection glass</i>		PIREX94/4/1	21,00

Colours: trasparente,  
giallo oro

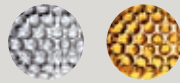

Weight:  
*Caboche media*  
net kg 4,50

*Caboche piccola*  
net kg 2,60

Light bulbs not  
included  
→ specifications p. 186

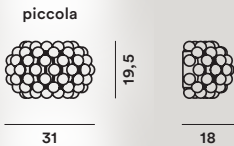
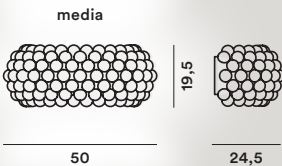

collection →

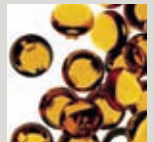
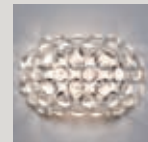
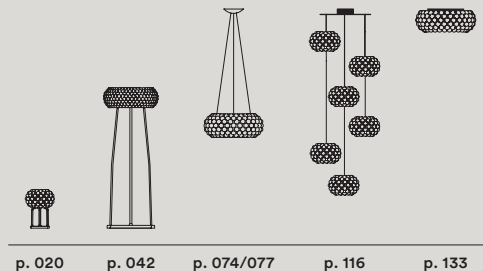

## Circus

Defne Koz, 1994



Blown glass, nickel-plated or coated metal

*Circus grande*  
Max 4x46W E27

*Circus piccola*  
Max 4x30W E14

⊕ CE IP 20

	energy cl.	colours	code	€ vat excluded
<i>Circus grande</i>	A <sup>+</sup> , A	bianco	0460081 11	428,00
<i>Circus piccola</i>	A <sup>+</sup> , A	bianco	046008 11	272,00

### Spare parts:

<i>Glass Circus grande</i>	bianco	046S001 11	275,00
<i>Glass Circus piccola</i>	bianco	046S00 11	153,00

Colours: bianco



Weight:

*Circus grande*  
net kg 4,70

*Circus piccola*  
net kg 2,10

Light bulbs not included  
→ specifications p. 186

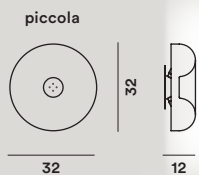
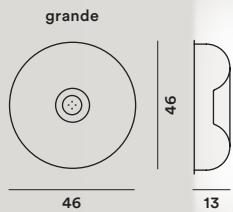

collection →



p. 134

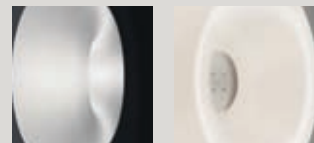

**Double**

Valerio Bottin, 1996



	energy cl.	colours	code	€ vat excluded
<i>Double</i>	A <sup>+</sup> , A	bianco	069005 11	274,00
		avorio	069005 51	
<b>Spare parts:</b>				
<i>Glass Double</i>		bianco	069S00 11	161,00
		avorio	069S00 51	

Blown glass and coated metal

Max 2x77W E27

⊕ CE IP 20

Colours: bianco, avorio



Weight:  
netto kg 2,00

Light bulbs not included  
→ specifications p. 186

Tecnico — 2019



26

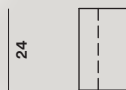

24

13

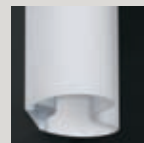

## Fields

Vicente Garcia Jimenez,  
2007



Methacrylate, coated  
aluminium and  
polycarbonate

*Fields 1*  
Fluo 1x80W G5

*Fields 2*  
Fluo 1x54W G5

*Fields 3*  
Fluo 1x39W G5

Horizontal and vertical use

*Fields*  
Fluo 1x80W G5 + 1x54W G5  
+ 1x39W G5

⊕ CE IP 20

	energy cl.	colours	code	€ vat excluded
<i>Fields</i>	A <sup>+</sup> , A	bianco	174005 10	1.880,00
		arancio	174005 63	
<i>Fields 1</i>	A <sup>+</sup> , A	bianco	1740051 10	583,00
		arancio	1740051 63	
<i>Fields 2</i>	A <sup>+</sup> , A	bianco	1740052 10	684,00
		arancio	1740052 63	
<i>Fields 3</i>	A <sup>+</sup> , A	bianco	1740053 10	613,00
		arancio	1740053 63	
<b>Spare parts:</b>				
<i>Set lampshades Fields 2</i>		bianco	174S002 10	89,00
		arancio	174S002 63	
<i>Set lampshades Fields 3</i>		bianco	174S003 10	87,00
		arancio	174S003 63	

Colours:  
bianco, arancio



Weight:  
*Fields 1*  
net kg 6,00

*Fields 2*  
net kg 6,50

*Fields 3*  
net kg 5,80

*Fields*  
net kg 18,30

Light bulbs not included  
→ specifications p. 186

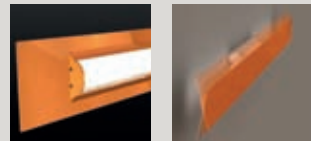
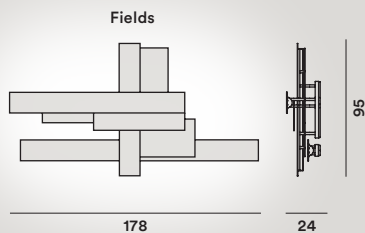
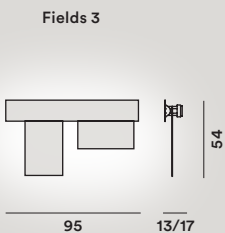
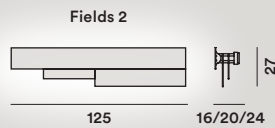
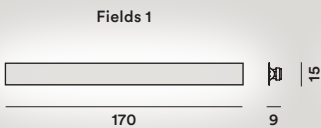

**Filo**

Andrea Anastasio, 2017

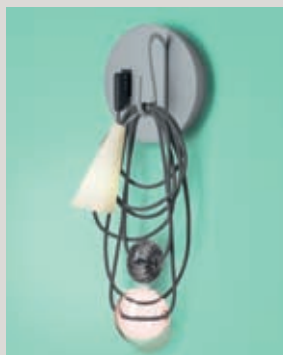

	energy cl.	colours	code	€ vat excluded
<b>Filo</b>	A++	amethyst queen	289005-01	353,00
		eastern coral	289005-02	
		teodora	289005-04	
		emerald king	289005-08	

Porcelain, textile cable, blown glass and varnished metal

LED retrofit included  
4W G9 3000 K  
400 lm CRI>80



Colours:

*Amethyst Queen*

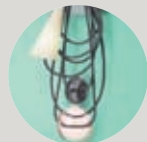

*Eastern Coral*



*Teodora*

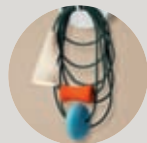

*Emerald King*

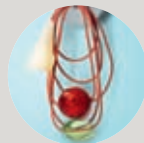

Weight:  
net kg 2,40

Tecnico — 2019

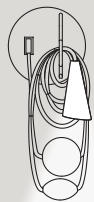

23

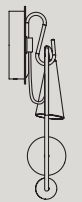

16

57

collection →



p. 021



p. 044





## Folio

Carlo Urbinati e Alessandro Vecchiato, 1990



	energy cl.	colours	code	€ vat excluded
<i>Folio grande</i>	A <sup>+</sup> , A, C	bianco	0190051 10	343,00
<i>Folio piccola</i>	A <sup>+</sup> , A, C	bianco	019005-R1 10	257,00

### Spare parts:

<i>Glass Folio grande</i>	bianco	019S001 10	215,00
<i>Glass Folio piccola</i>	bianco	019S00 10	134,00
<i>Halogen protection glass</i>	bianco	PIREX94/4/I	21,00

Blown acid-etched glass and coated metal

Max 1x120W R7s

⊕ CE IP 20

Colours: bianco



Weight:

*Folio grande*  
net kg 2,17

*Folio piccola*  
net kg 1,48

Light bulbs not included  
→ specifications p. 186

grande

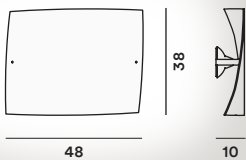

collection →



piccola

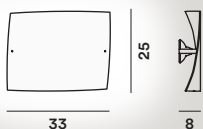

p. 135

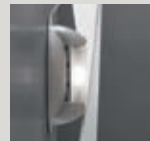

**Gregg**

Ludovica + Roberto  
Palomba, 2007



	energy cl.	colours	code	€ vat excluded
<i>Gregg media</i>	A <sup>+</sup> , A,	bianco	168005 10	313,00
<i>Gregg MIDI</i>	A	bianco	1680053-10	237,00
<i>Gregg piccola</i>	A <sup>+</sup> , A, C	bianco	1680052 10	147,00
<b>Spare parts:</b>				
<i>Glass Gregg media</i>		bianco	168S00 10	180,00
<i>Glass Gregg MIDI</i>		bianco	168S003-10	91,00
<i>Glass Gregg piccola</i>		bianco	168S00210	60,00

Blown acid-etched glass and coated metal

Colours: bianco



Weight:  
*Gregg media*  
net kg 2,90

Light bulbs not included  
→ specifications p. 186

*Gregg media*  
Max 1x150W E27

LED and dimming  
→ specifications p. 185

*Gregg MIDI*  
LED included COB 8,5W  
2700 K 830 lm CRI>80  
Dimmable with  
TRIAC technology

*Gregg MIDI*  
nett kg 1,60



*Gregg piccola*  
net kg 0,60

*Gregg piccola*  
Max 1x20W G9



media

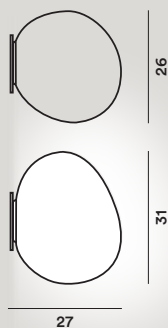

MIDI

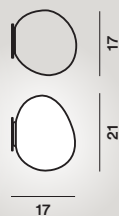

piccola



collection →

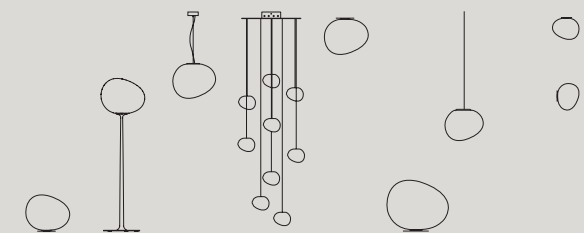

p. 023/031 p. 046 p. 096/097 p. 116 p. 136 p. 173 p. 179 p. 183

# Havana

Joseph Forakis, 1993



	energy cl.	colours	code	€ vat excluded
<i>Havana</i>	A <sup>+</sup> , A	bianco	0400072-R1 10	223,00
<b>Spare parts:</b>				
<i>Set lampshades Havana</i>		bianco	040S00 10	81,00

Injection moulded polyethylene and coated metal

Max 1x116W E27



Colours: bianco



Weight: net kg 1,90

Light bulbs not included → specifications p. 186

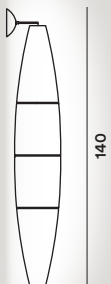

27

collection →

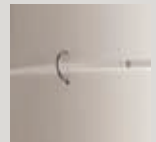
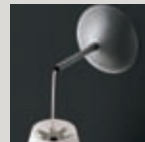
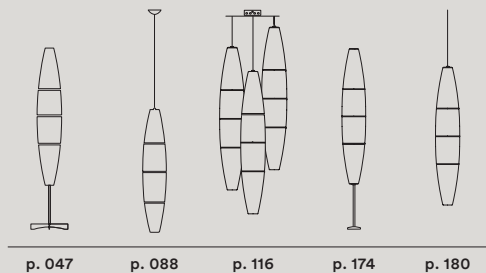

## Innerlight

Simon Pengelly, 2012



	energy cl.	colours	code	€ vat excluded
<i>Innerlight</i>	A <sup>+</sup> , A	bianco	233005 10	420,00
<i>Innerlight dimmable</i>	A <sup>+</sup> , A	bianco	233005DM 10	485,00

Translucent polycarbonate and coated or acid-etched steel

Fluo 2x36W 2G11

Dimmable version  
Possible configurations:  
On-Off/Push/DALI

⊕ CE IP 20

Colours: bianco



Weight:  
net kg 5,00

Light bulbs not included  
→ specifications p. 186

LED and dimming  
→ specifications p. 185

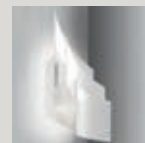

**Kite**

Marc Sadler, 2003



Fiberglass fabric with carbonium thread

Max 3x30W E14

⊕ CE IP 20

	energy cl.	colours	code	€ vat excluded
<i>Kite</i>	A <sup>+</sup> , A	nero	1110051 20	277,00
<b>Spare parts:</b>				
<i>Lampshade Kite</i>		nero	111S005 20	205,00

Colours: nero



Weight:  
net kg 0,50

Light bulbs not included  
→ specifications p. 186

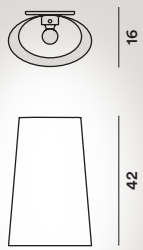

27

collection →

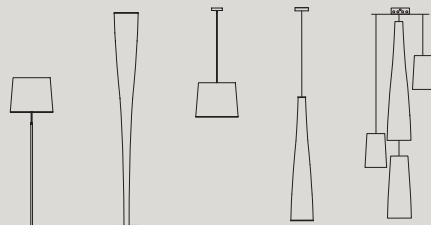

p. 045

p. 050

p. 085

p. 105

p. 116

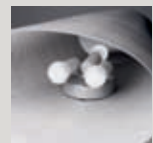

**Lake**

Lucidi e Pevere, 2015

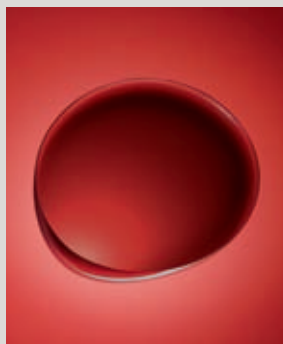

	energy cl.	colours	code	€ vat excluded
<i>Lake</i>	A	avorio	257005 50	437,00
		rosso	257005 63	

Varnished injection-molded ABS and aluminum

LED included  
12,7W Acrich 3000 K  
850 lm CRI>80  
Dimmable only with Seoul-Acrich LED compatible modules

☐ CE IP 20

Colours: avorio, rosso



Weight:  
net kg 5,50

LED and dimming  
→ specifications p. 185

Tecnico — 2019

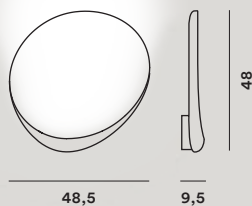

## Le Soleil

Vicente Garcia Jimenez,  
2013



	energy cl.	colours	code	€ vat excluded
<i>Le Soleil</i>	A <sup>+</sup> , A	bianco	181005 10	299,00
		rosso	181005 63	
<i>Le Soleil dimmable</i>	A <sup>+</sup> , A	bianco	181005DM 10	374,00
		rosso	181005DM 63	
<b>Spare parts:</b>				
<i>Set lampshades Le Soleil</i>		bianco	181S005 10	120,00
		rosso	181S005 63	

Injection moulded varnished polycarbonate and coated metal

Fluo 2x26W G24-q3

Dimmable version  
Possible configurations:  
On-Off/Push/DALI

⊕ CE IP 20

Colours: bianco, rosso



Weight:  
net kg 1,60

Light bulbs not included  
→ specifications p. 186

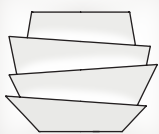

37

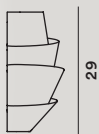

14

collection →



p. 089



**Lumiere XXL + XXS**

Rodolfo Dordoni, 2010



Blown glass and lacquered metal

**Lumiere XXL LED**

LED included  
32W 2700K  
2720 lm CRI>80  
Dimmable with TRIAC technology

**Lumiere XXL fluo**

Fluo 1x40W + 1x22W 2GX13  
Dimmable Fluo 1x55W 2GX13  
Dimmable version  
Possible configurations:  
On-Off/Push/DALI

**Lumiere XXS LED**

LED included  
18W 2700 K  
1521 lm CRI>80  
Dimmable with TRIAC technology

**Lumiere XXS fluo**

Fluo 2x18W G24q-2

⊕ CE IP 20

	energy cl.	colours	code	€ vat excluded
<b>Lumiere XXL LED</b>	A <sup>+</sup>	bianco	191005L-11	374,00
		grigio	191005L-24	416,00
<b>Lumiere XXL fluo *</b>	A <sup>+</sup> , A	bianco	191005 11	365,00
<b>Lumiere XXL fluo dimm. *</b>	A <sup>+</sup> , A	bianco	191005DM 11	438,00
<b>Lumiere XXS LED</b>	A <sup>+</sup>	bianco	1910052L-11	314,00
		grigio	1910052L-24	335,00
<b>Lumiere XXS fluo *</b>	A <sup>+</sup> , A	bianco	1910052 11	312,00
<b>Spare parts:</b>				
<b>Glass Lumiere XXL LED</b>		bianco	191S0051R1-11	205,00
		grigio	191S0051R1-24	247,00
<b>Glass Lumiere XXS LED</b>		bianco	191S0052R1-11	148,00
		grigio	191S0052R1-24	169,00
<b>Glass Lumiere XXL fluo</b>		bianco	191S0051 11	205,00
		grigio	191S0051-24	247,00
<b>Glass Lumiere XXS fluo</b>		bianco	191S0052 11	148,00
		grigio	191S0052-24	169,00

\* Limited stock available

Colours: bianco,  
grigio freddo



Weight:  
**Lumiere XXL**  
net kg 3,40

**Lumiere XXS**  
net kg 1,80

Light bulbs not included  
→ specifications p. 186

LED and dimming  
→ specifications p. 185

Lumiere XXL

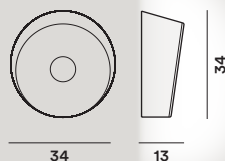

Lumiere XXS

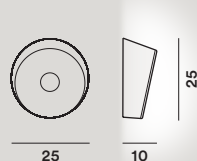

collection →

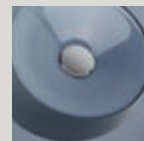
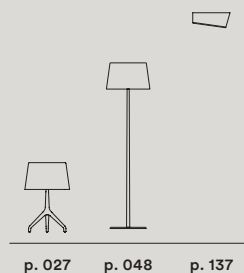



## Nuage

Philippe Nigro, 2012

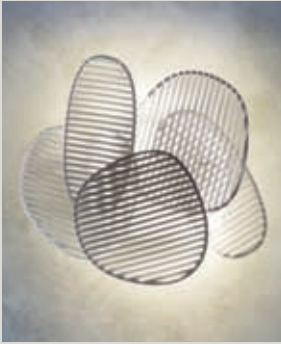

Injection-moulded polycarbonate and batch-dyed ABS

Fluo 1x40W + 1x22W 2GX13  
Dimmable 1x55W 2GX13

Dimmable version  
Possible configurations:  
On-Off/Push/DALI

Usable in composition

⊕ CE IP 20

	energy cl.	colours	code	€ vat excluded
<b>Nuage</b>	A <sup>+</sup> , A	bianco	243005 10	415,00
		rosso*	243005 63	
<b>Nuage dimmable</b>	A <sup>+</sup> , A	bianco	243005DM 10	469,00
		rosso*	243005DM 63	
<b>Accessories</b>				
<b>Lamp connection set</b>		40+22W	243KIT	27,00
		dimmable	243KIT DM	41,00
<b>Spare parts:</b>				
<b>Set lampshades Nuage</b>		bianco	243S00 10	286,00
		rosso*	243S00 63	

\* Limited stock available

Colours: bianco,



rosso\*

\* Limited stock available



Weight:  
net kg 3,20

Light bulbs not included  
→ specifications p. 186

LED and dimming  
→ specifications p. 185

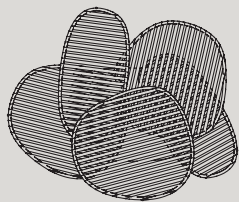

63

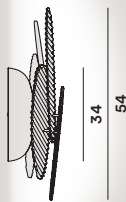

16

collection →



p. 138

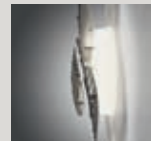

## Rituals

Ludovica + Roberto  
Palomba, 2015



	energy cl.	colours	code	€ vat excluded
<i>Rituals 1</i>	A <sup>+</sup> , A	bianco	2440051 10	382,00
<i>Rituals 3</i>	A <sup>+</sup> , A	bianco	2440053 10	334,00
<i>Rituals 1 doppia</i> ●	A <sup>+</sup> , A	bianco	24400512 10	707,00
<i>Rituals 3 doppia</i> ●	A <sup>+</sup> , A	bianco	24400532 10	613,00
<b>Spare parts:</b>				
<i>Glass Rituals 1</i>		bianco	244S001 10	226,00
<i>Glass Rituals 3</i>		bianco	244S003 10	170,00

Blown satin glass and  
lacquered metal

*Rituals 1-3*  
Max 1x70W E27

*Rituals 1-3 doppia*  
Max 2x70W E27



Colours: bianco



Weight:  
*Rituals 1*  
net kg 4,80

*Rituals 3*  
net kg 2,40

*Rituals 1 doppia*  
net kg 8,80

*Rituals 3 doppia*  
net kg 6,00

Light bulbs not included  
→ specifications p. 186

●  
**On demand:**  
lead times to be checked  
with the sales department

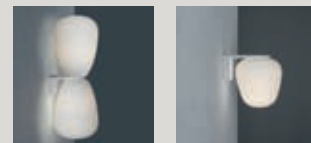
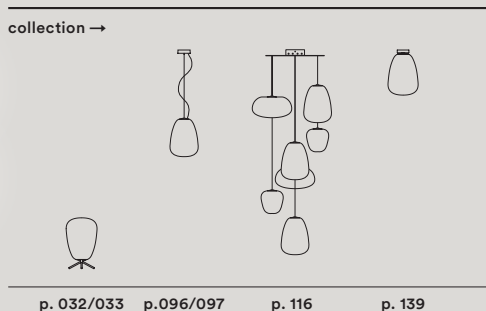
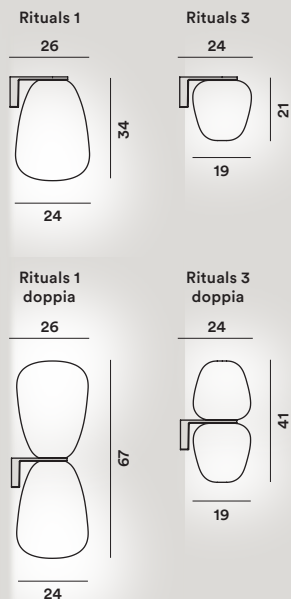

**Satellite**

Eugeni Quitllet, 2017

LED



Blown glass and lacquered  
aluminium

LED included  
6W 2700 K 504 lm CRI>80  
Dimmable with TRIAC  
technology

⊕ CE IP 20

	energy cl.	colours	code	€ vat excluded
<b>Satellite</b>	A <sup>+</sup>	bianco/trasp.	285025-15	339,00

Colours:  
bianco / trasparente

Weight:  
net kg 2,00

LED and dimming  
→ specifications p. 185

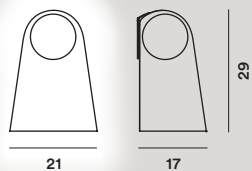

collection →



p. 034

p. 099

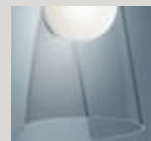

**Superficie**

Calvi & Brambilla, 2017

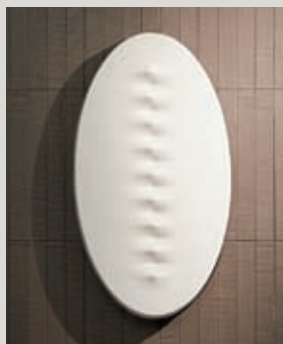

<i>Superficie</i>	energy cl.	colours	code	€ vat excluded
	A <sup>+</sup>	bianco	284005-10	566,00

Thermoformed PMMA and aluminium

LED included  
36W 2700 K  
3060 lm CRI>80

Dimmable with TRIAC technology

Horizontal and vertical use



Colours: bianco



Weight:  
net kg 2,40

LED and dimming  
→ specifications p. 185

Tecnico — 2019

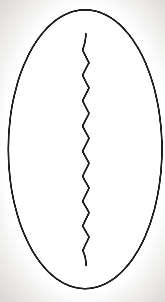

41

75



5

collection →

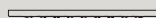

p. 140

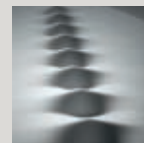

**Tress**

Marc Sadler, 2011

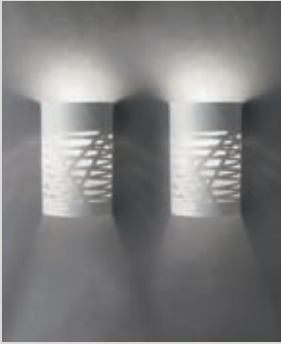

Coated fibreglass-based composite material and coated metal

Max 1x120W R7s

⊕ CE IP 20

	energy cl.	colours	code	€ vat excluded
<i>Tress grande</i>	A <sup>+</sup> , A, C	bianco	182005 10	403,00
		nero	182005 20	
<i>Tress piccola</i>	A <sup>+</sup> , A, C	bianco	1820052 10	364,00
		nero	1820052 20	
<b>Spare parts:</b>				
<i>Lampshade Tress grande</i>		bianco	182S005 10	260,00
		nero	182S005 20	
<i>Lampshade Tress piccola</i>		bianco	182S0052 10	221,00
		nero	182S0052 20	
<i>Halogen protection glass</i>			PIREX94/4/1	21,00

Colours: bianco, nero



Weight:  
*Tress grande*  
net kg 1,10

*Tress piccola*  
net kg 1,00

Light bulbs not included  
→ specifications p. 186

grande

piccola

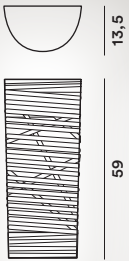

25

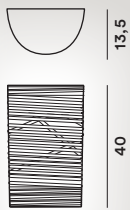

25

collection →



p. 052



p. 053



p. 106/108



p. 109



p. 116

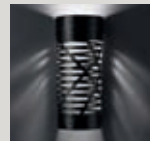

**Tutù**

Valerio Bottin, 2001



	energy cl.	colours	code	€ vat excluded
<i>Tutù</i>	A <sup>+</sup> , A	bianco	1140051 11	194,00
		avorio	1140051 51	

**Spare parts:**

<i>Glass Tutù</i>	bianco	114S005 11	91,00
	avorio	114S005 51	

Blown glass, metal and aluminium

Max 2x46W E14

⊕ CE IP 20

Colours: bianco, avorio



Weight:  
net kg 0,80

Light bulbs not included  
→ specifications p. 186

Tecnico — 2019

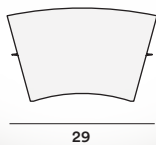







Esterno, *Outdoor*

- 172 **Cri Cri**  
*tavolo*
- 173 **Gregg**  
*terra*
- 174 **Havana**  
*terra*
- 175 **Solar**  
*terra*
- 176 **Twiggy Grid**  
*terra*
- 177 **Twiggy Grid**  
**Lettura - XL**  
*terra*
- 178 **Aplomb**  
*sospensione*
- 179 **Gregg**  
*sospensione*
- 180 **Havana**  
*sospensione*
- 181 **Twiggy Grid**  
*sospensione*
- 182 **Uto**  
*sospensione*
- 183 **Gregg MIDI**  
*parete / soffitto*

**Cri Cri**

Studio Natural, 2017



	energy cl.	colours	code	€ vat excluded
<i>Cri Cri</i>	A	verde	286001-40	327,00
		rosso	286001-63	

Silicone, ABS and PMMA

LED 2,4W 2700 K  
 325 lumen CRI>80  
 Integrated touch-dimmer  
 USB charge - cable included  
 Charger (not included) 1 A  
 Charge lifetime approx. 10  
 hours (highest power)  
 Recharging time approx. 9  
 hours  
 Cicles of recharge 500/700

Colours: verde, rosso



Weight:  
 net kg 1,00

⚡ CE IP 65

Tecnico — 2019

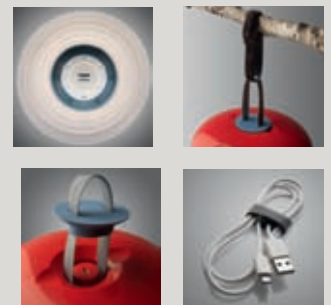
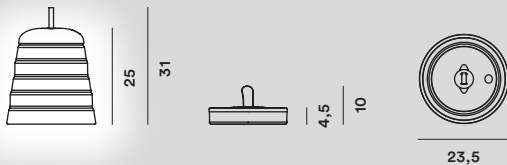

## Gregg outdoor

terra

Ludovica + Roberto

Palomba, 2011



Rotational moulded polyethylene and coated metal

*X-large / grande*  
Max 1x25W E27

*media*  
Max 1x15W E27

CE IP 65 - IP 44

	energy cl.	colours	code	€ vat excluded
<i>Gregg outdoor X-large</i>	A <sup>+</sup> , A	bianco	218003 10	335,00
<i>Gregg outdoor grande</i>	A <sup>+</sup> , A	bianco	218013 10	255,00
<i>Gregg outdoor media</i>	A <sup>+</sup> , A	bianco	218023 10	196,00
<b>Spare parts:</b>				
<i>Lampshade Gregg outdoor X-large</i>		bianco	218S001 10	183,00
<i>Lampshade Gregg outdoor grande</i>		bianco	218S00 10	103,00
<i>Lampshade Gregg outdoor media</i>		bianco	218S002 10	64,00

Colours: bianco



Weight:  
*X-large*  
net kg 4,30

*grande*  
net kg 3,60

*media*  
net kg 1,60

Light bulbs not included  
→ specifications p. 186

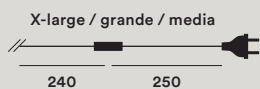
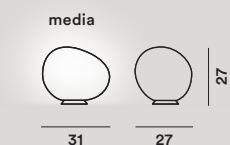
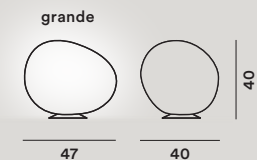
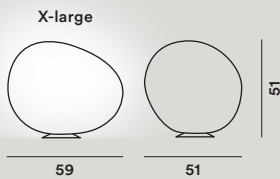

collection →

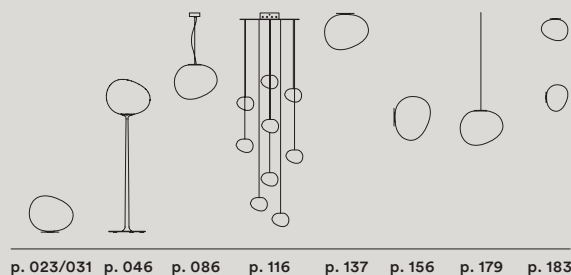

IP 44



IP 65



## Havana outdoor

terra

Jozeph Forakis, 2005

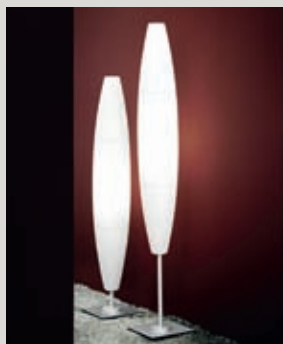

	energy cl.	colours	code	€ <del>vat</del> included
<i>Havana out. terra undergr. base</i>	A+, A	bianco	150003 10	671,00
<i>Havana out. terra stake mounted</i>	A+, A	bianco	1500031 10	563,00
<i>Havana out. terra base</i>	A+, A	bianco	1500032 10	601,00
<i>Havana out. terra bassa undergr. base</i>	A+, A	bianco	150004 10	653,00
<i>Havana out. terra bassa stake mounted</i>	A+, A	bianco	1500041 10	546,00
<i>Havana out. terra bassa base</i>	A+, A	bianco	1500042 10	584,00

**Spare parts:**

<i>Lampshade Havana outdoor</i>	bianco	150S00 10	160,00
<i>Underground base</i>		150S032	123,00
<i>Stake mounted</i>		150S031	113,00
<i>Base</i>		150S033-R1	151,00

Rotational moulded polyethylene and coated metal

Max 1x46W E27

☐ CE IP 65 - IP 44

Colours: bianco



Weight:  
*Underground base*  
net kg 5,50

*Stake mounted*  
net kg 5,20

*Base*  
net kg 10,10

Light bulbs not included  
→ specifications p. 186

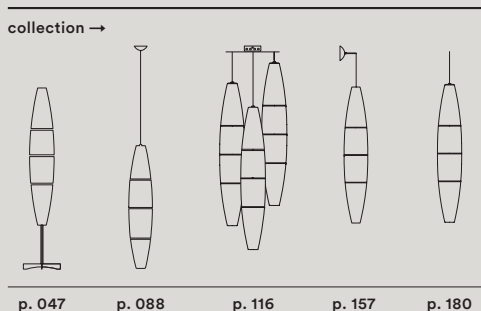
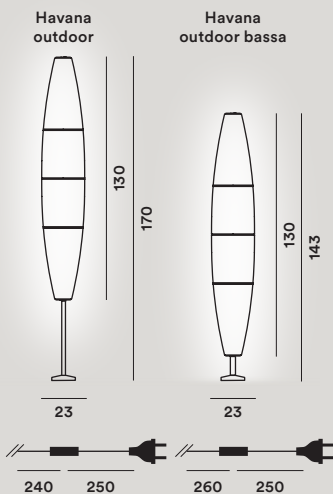
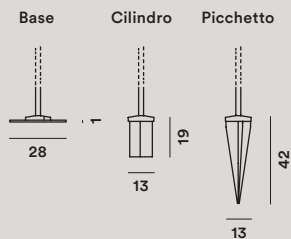

Tecnico — 2019



## Solar

Jean Marie Massaud, 2011



Rotational moulded polyethylene, porcelain stoneware top shelf and coated metal

Max 1x25W E27

Reclinable up to 15°

☐ CE ⚡ IP 65 - IP 44

	energy cl.	colours	code	€ vat excluded
<i>Solar</i>	A <sup>+</sup> , A	marrone	228003M	762,00
<b>Spare parts:</b>				
<i>Lampshade Solar</i>		bianco	228S11 10	234,00
<i>Top disk Solar</i>		marrone	228S101M-R1	351,00

Colours: marrone



Weight:  
net kg 11,70

Light bulbs not included  
→ specifications p. 186

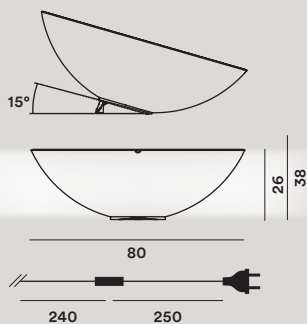

IP 44



IP 65

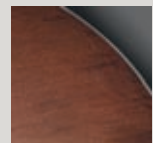

## Twiggy Grid

Marc Sadler, 2017

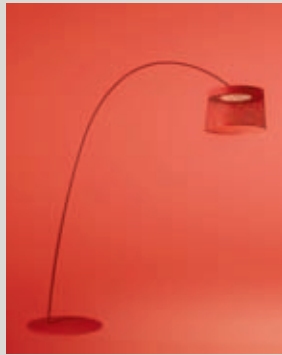

Varnished fibreglass based composite material, PMMA, varnished metal and aluminium

LED included  
Mid power 31W 2700 K  
2010 lm CRI>90

☐ CE IP 44 - IP 65

	energy cl.	colours	code	€ vat excluded
<i>Twiggy Grid</i>	A <sup>++</sup>	greige	290003-25	1.886,00
		carminio	290003-65	

**Accessories:**

<i>Additional stem set Twiggy Grid (40 cm + 40 cm)</i>	greige	159S031 25	170,00
	carminio	159S031 65	

**Spare parts:**

<i>Lampshade Twiggy Grid</i>	greige	290S00-25	918,00
	carminio	290S00-65	

Colours: greige, carminio Weight: net kg 17,10

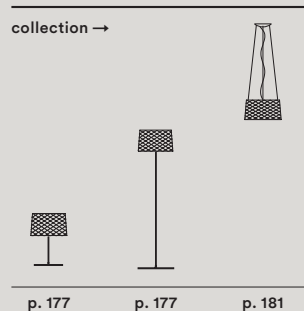
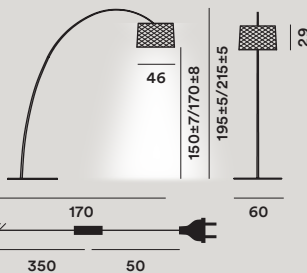
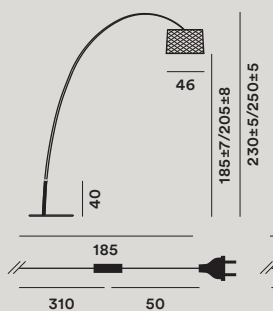
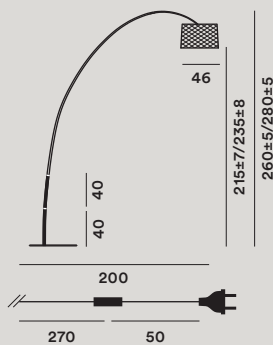

Tecnico — 2019

## Twiggy Grid Lettura + XL

Marc Sadler, 2018

LED



	energy cl.	colours	code	€ vat excluded
<i>Twiggy Grid lettura</i>	A <sup>++</sup>	greige	290004-25	1.430,00
		carminio	290004-65	
<i>Twiggy Grid XL</i>	A <sup>++</sup>	greige	2900011-25	1.279,00
		carminio	2900011-65	

Varnished fibreglass based composite material, PMMA, varnished metal and aluminium

Colours: greige, carminio



Weight:

*Twiggy Grid lettura*  
net kg 12,00

*Twiggy Grid XL*  
net kg 7,50

LED included  
Mid power 31W 2700 K  
2010 lm CRI>90

☐ CE IP 44 - IP 65

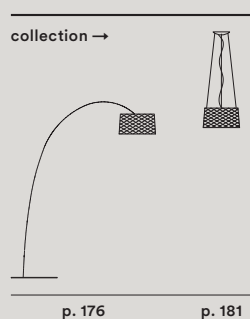
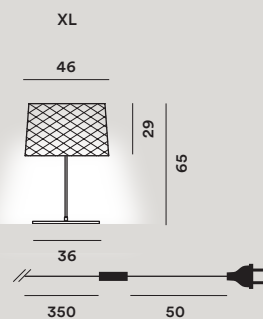
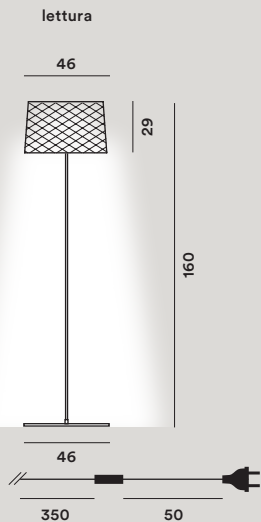

IP 44

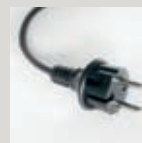

IP 65

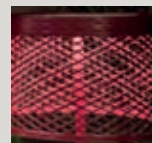
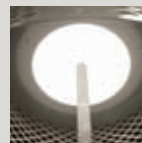

**Aplomb outdoor**

Lucidi e Pevere, 2017

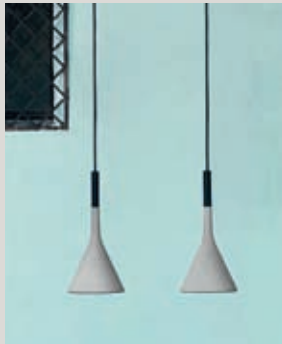
**LED**

Hand pouring concrete and  
aluminium

LED included  
COB 8W 2700 K  
680 lm CRI>80

Dimmable with  
TRIAC technology

Canopy not included

CE IP 44 - IP 65

	energy cl.	colours	code	€ vat excluded
<i>Aplomb outdoor</i>	A <sup>+</sup>	grigio	291007-26	377,00
		verde	291007-42	
		rosso	291007-65	
<b>Accessories:</b>				
<i>Kit cable reels outdoor</i>			291KIT-AVV	35,00

Colours:  
grigio cemento,  
verde oliva, rosso mattone

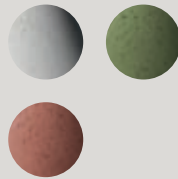

Weight:  
net kg 1,90

LED and dimming  
→ specifications p. 185

Tecnico — 2019

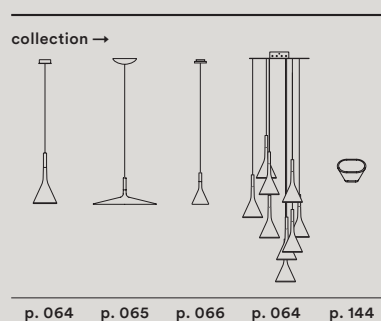
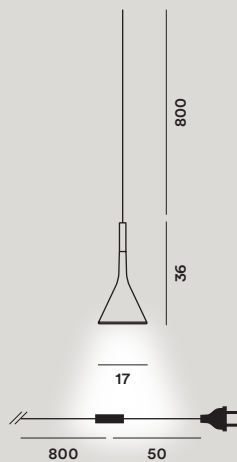



## Gregg outdoor

sospensione

Ludovica + Roberto Palomba,  
2011



Rotational moulded polyethylene and coated metal

*X-large / grande*  
Max 1x25W E27

*media*  
Max 1x15W E27

Canopy not included

☐ CE ⚡ IP 65 - IP 44

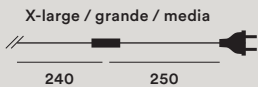
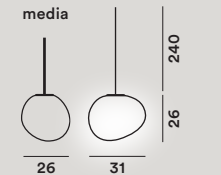
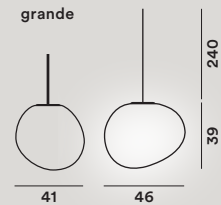
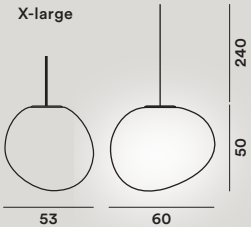

	energy cl.	colours	code	€ vat excluded
<i>Gregg outdoor X-large</i>	A <sup>+</sup> , A	bianco	218007 10	313,00
<i>Gregg outdoor grande</i>	A <sup>+</sup> , A	bianco	218017 10	233,00
<i>Gregg outdoor media</i>	A <sup>+</sup> , A	bianco	218027 10	187,00
<i>Gregg outdoor X-large h. 10 m</i> •	A <sup>+</sup> , A	bianco	218007/10-10	393,00
<i>Gregg outdoor grande h. 10 m</i> •	A <sup>+</sup> , A	bianco	218017/10-10	313,00
<i>Gregg outdoor media h. 10 m</i> •	A <sup>+</sup> , A	bianco	218027/10-10	267,00

Spare parts:

<i>Lampshade Gregg outdoor X-large</i>	bianco	218S001 10	183,00
<i>Lampshade Gregg outdoor grande</i>	bianco	218S00 10	103,00
<i>Lampshade Gregg outdoor media</i>	bianco	218S002 10	64,00

Accessories:

<i>Kit cable reels outdoor</i>		291KIT-AVV	35,00
--------------------------------	--	------------	-------

Colours: bianco



Weight:  
*X-large*  
net kg 3,70

*grande*  
net kg 3,00

*media*  
net kg 1,40

Light bulbs not included  
→ specifications p. 186

•  
H. 10 m on demand:  
lead times to be  
checked with the sales  
department

collection →

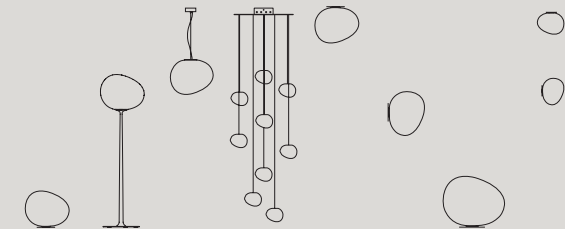

p. 023/031 p. 046 p. 086 p. 116 p. 136 p. 156 p. 173 p. 183

IP 44



IP 65



## Havana outdoor

sospensione

Jozeph Forakis, 2005



Rotational moulded polyethylene and coated metal

Max 1x46W E27

Canopy not included

☐ CE ⚡ IP 65 - IP 44

	energy cl.	colours	code	€ vat excluded
<i>Havana outdoor</i>	A+, A	bianco	150007 10	357,00
<i>Havana outdoor h. 10 m •</i>	A+, A	bianco	150007 10SP10	482,00
<b>Spare parts:</b>				
<i>Lampshade Havana Outdoor</i>		bianco	150S00 10	160,00
<b>Accessories:</b>				
<i>Kit cable reels outdoor</i>			291KIT-AVV	35,00

Colours: bianco



Weight:  
net kg 3,00

Light bulbs not included  
→ specifications p. 186

•  
**H. 10 m on demand:**  
lead times to be  
checked with the  
sales department

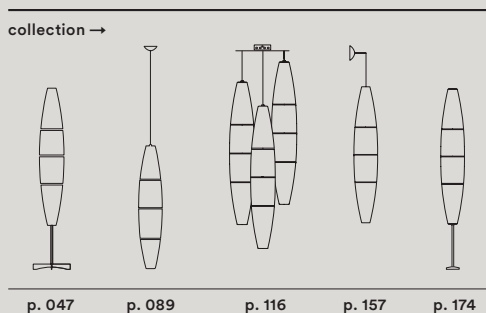
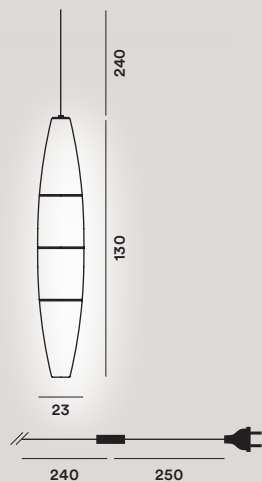

## Twiggy Grid sospensione

Marc Sadler, 2017



Varnished fibreglass based composite material, PMMA, varnished metal and aluminium

LED included  
Mid power 31W 2700 K  
2010 lm CRI>90

Ⓜ CE IP 44

LED

	energy cl.	colours	code	€ vat excluded
<i>Twiggy Grid</i>	A <sup>+</sup> , A	greige	290007-25	1.217,00
		carminio	290007-65	
<i>Twiggy Grid h. 10 m •</i>	A <sup>+</sup> , A	greige	290007/10-25	1.240,00
		carminio	290007/10-65	
<b>Spare parts:</b>				
<i>Lampshade Twiggy Grid</i>		greige	290S00-25	918,00
		carminio	290S00-65	

Colours: greige, carminio Weight:  
net kg 2,80



•  
**H. 10 m on demand:**  
lead times to be  
checked with the  
sales department

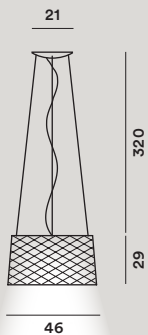

collection →

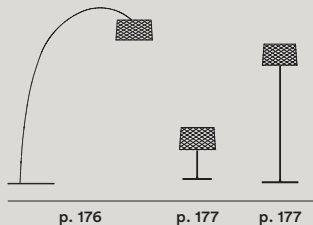

## Uto

Lagranja Design, 2005



	energy cl.	colours	code	€ vat excluded
<i>Uto</i>	A <sup>+</sup> , A	bianco	142000 10	356,00
		giallo	142000 50	
		arancio	142000 53	

Thermoplastic elastomer and polycarbonate

Max 1x12W E27

Switch inside the flexible tube

☐ CE ⚡ IP 65 - IP 44

Colours: bianco, giallo, arancio



Weight: net kg 2,00

Light bulbs not included → specifications p. 186

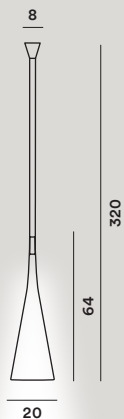

collection →

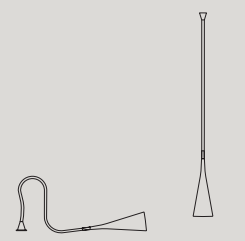

p. 037

p. 114



**Gregg MIDI**

Ludovica + Roberto  
Palomba, 2017



	energy cl.	colours	code	€ vat excluded
<i>Gregg MIDI</i>	A	bianco	1680053-10	237,00
<b>Spare parts:</b>				
<i>Glass Gregg MIDI</i>		bianco	168S003-10	91,00

Blown acid-etched glass and coated metal

LED included COB 8,5W  
2700 K 830 lm CRI>80  
Dimmable with TRIAC technology



Colours: bianco



Special colours on request

Weight:  
net kg 1,60

LED and dimming  
→ specifications p. 185

parete

soffitto

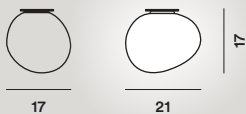
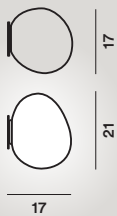

collection →

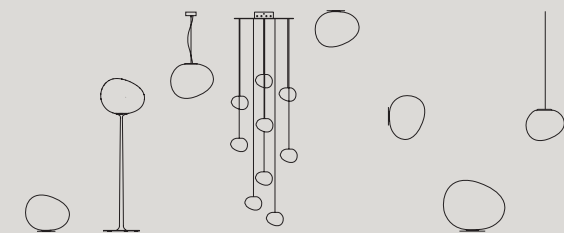

p. 023/031 p. 046 p. 086 p. 116 p. 136 p. 156 p. 173 p. 179

## MyLight Collection

The **MyLight models** use the smart device Casambi to control light intensity from 100% to complete turning off.

The system is easy and user-friendly. No new wiring, switch, device or Internet connection is needed. You only need to install the light source and match it through Bluetooth with your smart phone, tablet, or other control devices (see below). No further configurations by qualified staff are needed.

### Tunable White - Caboche

Besides light intensity control, with Caboche hanging light media, it's possible to control the LED light colour degree from 2500 K to 4500 K, from warm to natural or cold light through any intermediate level.

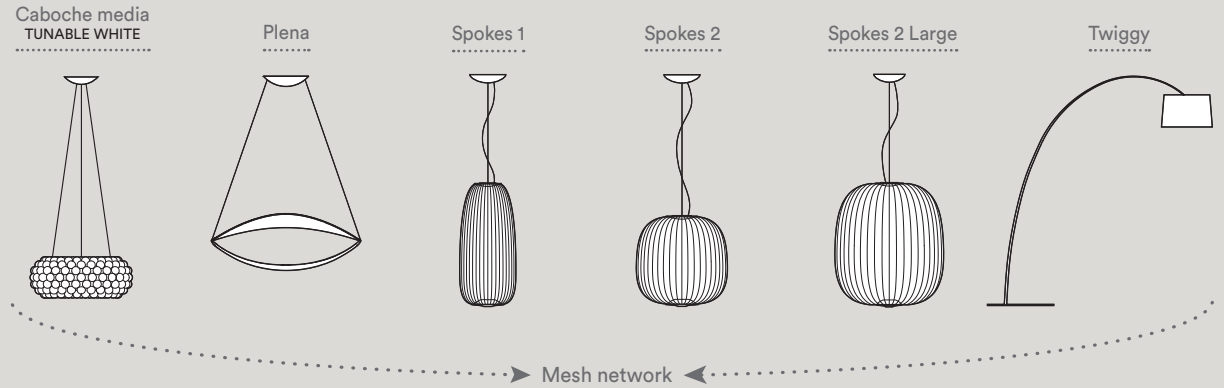

Controlled via Bluetooth - Casambi App [ iOS -  ]

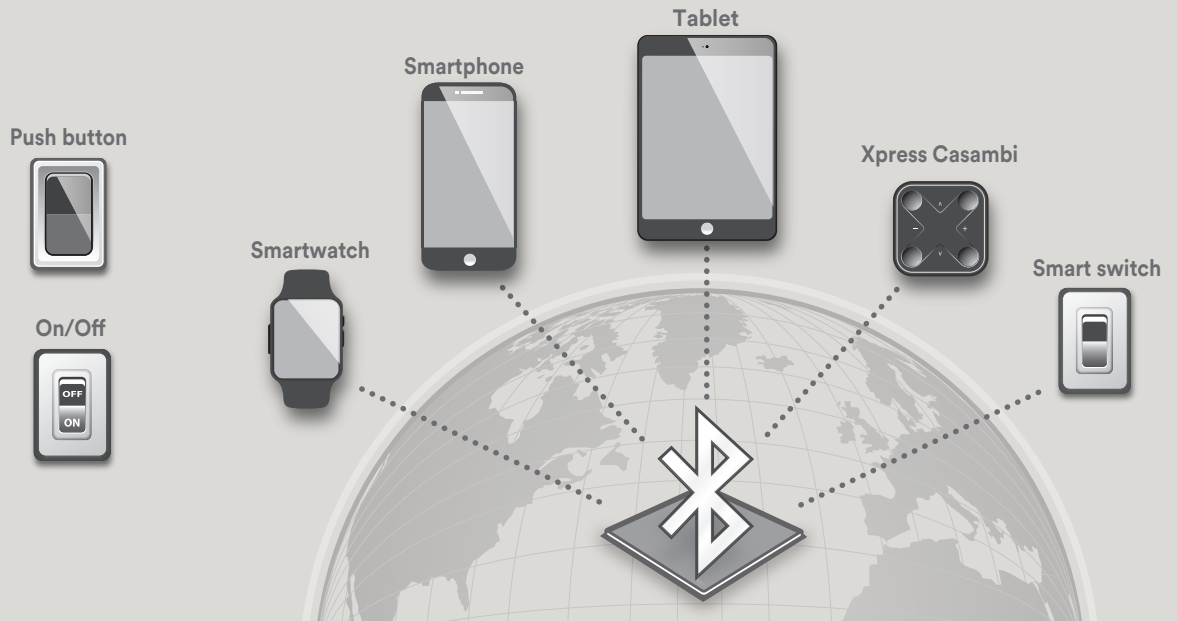

## LED and dimming

### Spare parts for lights with LED included.

LED modules can be replaced by qualified staff on-the-spot and the spare part can be purchased to the company for the following lights:

Allegro, Aplomb Large, Bahia – Bahia Mini, Big Bang – Big Bang L – Big Bang XL, Caboche grande – Caboche media, Chouchin – Chouchin reverse, Gem, Gregg Media, Lake, Le Soleil, Plass, Rituals XL, Satellight, Tartan, Tress grande, Tuareg, Twiggy, Twice as Twiggy.

### Dimming

The following lights can be dimmed with On/Off – Push – DALI configurations:

Allegro, Aplomb Large, Bahia – Bahia Mini, Big Bang – Big Bang L – Big Bang XL, Buds LED included, Caboche grande – Caboche media, Chouchin – Chouchin reverse LED included, Dolmen, Gregg grande – Gregg media LED included, Innerlight, Jamaica, Le Soleil, Lumiere XXL/S LED included, Nuage, Plena, Rituals XL LED included, Spokes 1 – Spokes 2 – Spokes 2 large, Tartan LED included, Tress grande, Troag, Twice as Twiggy.

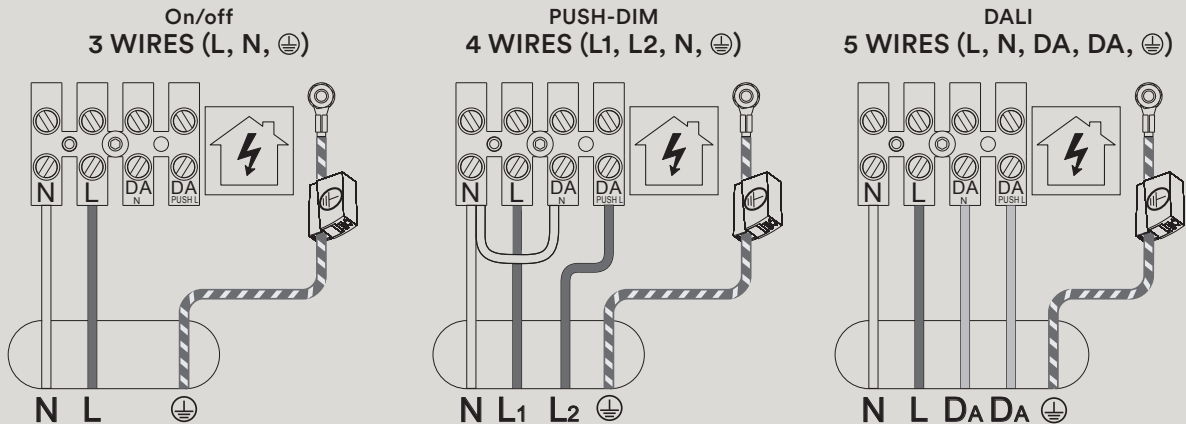

N = Neutro L = Linea DA = Dali PUSH = Dimmerabile Push

The following lights can be dimmed with TRIAC\* or AD IGBT technology:

Aplomb outdoor, Arumi, Caboche LED parete, Gregg Midi, Lumiere LED XXL - XXS parete, Satellight parete, Superficie.

The LED retrofit bulb included for the following lights is dimmable with TRIAC\* technology:

Buds – Chouchin – Gem – Gregg grande – Gregg media – Rituals XL – Satellight – Tartan.

\* the minimum power output (Watt) adjustable by the recessed light dimmer has to be lower than the light or the LED retrofit bulb power.

## Light Sources

**Halogen bulbs:** Starting from September 1st 2018, according to a European directive, some halogen light bulbs have been banned. This does not mean that they will no longer be sold, since they can be sold in stores until stocks run out. Directional halogen lamps (spotlights) and those with R7s - G9 and G4 lamp holders will continue to be available and sold.







If the use of a retrofit LED bulb in the lamp with lamp holder R7s is chosen, the supplied Pyrex protection glass must be removed.

**Lamps with dimmer:** Please verify the compatibility of your bulb with the dimmer's wattage ranges, indicated on the dimmer itself, according to the kind of light source.











**LED retrofit light bulbs:** Foscarini recommends the use of warm light bulbs for its whole collection. The light bulbs available on the market may feature technical specifications with various graphics and definitions, but a warm light tone is generally described as Warm White - 2700-3000K° and CRI > 80.

This table contains the necessary information to purchase the correct light source (models with integrated LED excluded).

\* Expressed in mm

Model	Version	Type	Fitting Base	Length*	Width*	Notes
<i>Allegretto</i>	sospensione	Halo / LED retrofit	E27-PAR	max 85	Ø96	
<i>Allegro</i>	sospensione	Halo / LED retrofit	E27-PAR / R7s	max 99 (E27 PAR) 118 (R7s)	Ø96	
<i>Aplomb GU 10</i>	sospensione	LED retrofit	GU10-PAR	max 80	Ø80	
<i>Aplomb mini</i>	sospensione	LED retrofit	GU10-PAR	max 80	Ø80	
<i>Aplomb G9</i>	sospensione	Halo / LED retrofit	G9	max 60	max Ø18	
<i>Bahia-Bahia mini</i>	soffitto/parete	Fluo	2GX13 T16-R	300/230	Ø16	
<i>Behive</i>	tavolo	Halo / LED retrofit dimm.	E27		max Ø65	
<i>Behive</i>	sospensione	LED retrofit / Fluo / Halo	E27		max Ø65	
<i>Big Bang</i>	sospensione	Halo / LED retrofit	R7s	118	max Ø29	
<i>Big Bang</i>	soffitto/parete	Halo / LED retrofit	R7s	78	max Ø25	
<i>Binic</i>	tavolo	LED retrofit / Fluo	E14	max 110	max Ø40	
<i>Birdie</i>	tavolo grande /terra /sosp gr.	LED retrofit / Fluo / Halo	E27	max 180	max Ø120	
<i>Birdie</i>	tav. piccolo /sosp./soff./par.	LED retrofit / Fluo / Halo	E27	max 110	max Ø80	
<i>Bit</i>	parete	LED retrofit / Fluo / Halo	E14	max 140	max Ø45	
<i>Blob</i>	soffitto/parete	Fluo	2G11	320	//	
<i>Buds</i>	tavolo / sospensione	LED retrofit / Fluo	E27	white globe Ø 120 for Buds 1-2 Ø 90 for Buds 3		
<i>Caboche</i>	sospensione piccola/tavolo	Halo / LED retrofit	G9	max 60	max Ø18	
<i>Caboche</i>	terra/sospensione/soffitto	Halo / LED retrofit	R7s	118	max Ø29	
<i>Caboche</i>	parete	Halo / LED retrofit	R7s	78	max Ø25	
<i>Caiigo</i>	sospensione	LED retrofit / Halo	GU10-PAR	max 62	max Ø51	
<i>Chouchin 1-2-3 &amp; reverse</i>	sospensione	LED retrofit / Fluo / Halo	E27/E27 PAR	max 150	max Ø100	
<i>Chouchin mini</i>	sospensione	LED retrofit / Halo	GU10-PAR	max 60	max Ø55	
<i>Circus grande</i>	soffitto/parete	LED retrofit / Fluo / Halo	E27	max 100	max Ø70	
<i>Circus piccola</i>	soffitto/parete	LED retrofit / Fluo / Halo	E14	max 70	max Ø50	
<i>Double</i>	parete	LED retrofit / Fluo / Halo	E27	max 110	max Ø60	
<i>Fields 1-2-3</i>	parete	Fluo	G5	1449/1149/849	Ø16	
<i>Filo</i>	tavolo/lettura/parete	LED retrofit	G9	max 70	max Ø20	
<i>Folio grande piccola</i>	soffitto/parete	Halo / LED retrofit	R7s	78	max Ø25	
<i>Gem</i>	tavolo/sospensione	LED retrofit / Fluo / Halo	E27	max 150	max Ø67	
<i>Giga-Lite</i>	terra/sospensione	LED retrofit dimmerabile / Fluo dimmerabile / Halo *	E27	max 150	max Ø80	
<i>Gregg grande</i>	tavolo/sospensione/terra	LED retrofit dimmerabile / Fluo dimmerabile / Halo *	E27	max 140	max Ø60	
<i>Gregg media</i>	tavolo/terra/sosp./soff./par.	LED retrofit dimmerabile / Fluo dimmerabile / Halo *	E27	max 140	max Ø60	
<i>Gregg piccola</i>	tavolo/sosp./soffitto/parete	Halo / LED retrofit	G9	max 60	max Ø18	
<i>Havana</i>	terra/sospensione/parete	LED retrofit dimmerabile / Fluo dimmerabile / Halo *	E27	max 125	max Ø60	
<i>Havana outdoor</i>	terra/sospensione	LED retrofit / Fluo / Halo	E27		max Ø60	
<i>Innerlight</i>	parete	Fluo	2G11	415	//	
<i>Kite</i>	parete	LED retrofit / Fluo / Halo	E14		max Ø50	



Model	Version	Type	Fitting Base	Lenght*	Width*	Notes
<i>Kurage</i>	tavolo	LED retrofit / Fluo	E27	max 135	max Ø65	
<i>Le Soleil</i>	sospensione	Halo / LED retrofit	E27/GU10 PAR	max 145 (E27)	max Ø80 (E27)	
<i>Le Soleil</i>	parete	Fluo	G24q-3	130	//	
<i>Lightweight</i>	sospensione	Halo	G4 12v			
<i>Lumiere grande piccola</i>	tavolo	Halo / LED retrofit	G9	max 60	max Ø20	
<i>Lumiere XXL XXS</i>	tavolo	Halo / LED retrofit	G9	max 60	max Ø20	
<i>Lumiere XXL</i>	soffitto/parete	Fluo	2GX13 T16-R	300	Ø16	
<i>Lumiere XXS</i>	soffitto/parete	Fluo	2G24q-2	140	//	
<i>Maki</i>	sospensione	LED retrofit / Halo	GU10-PAR		max Ø55	
<i>Mite</i>	terra	Halo / LED retrofit dimm.	E27	max 145	max Ø60	
<i>Nuage</i>	soffitto/parete	Fluo	2GX13 T16-R	300/230	Ø16	
<i>Orbital</i>	terra	Halo	E14	max 85	max Ø45	
<i>O-Space</i>	sospensione	Halo / LED retrofit	R7s	78	max Ø25	
<i>Plass media</i>	tavolo	LED retrofit dimmerabile / Fluo dimmerabile / Halo *	E27		max Ø60	
<i>Plass media</i>	sospensione	LED retrofit / Fluo / Halo	E27		max Ø60	
<i>Plass grande</i>	sospensione	Halo	G9/GU10 PAR		max Ø60 (GU10 PAR)	
<i>Polygregg grande</i>	tavolo	LED retrofit / Fluo	E27		max Ø60	
<i>Gregg outdoor XL -grande</i>	tavolo/terra out./ sosp. out.	LED retrofit / Fluo	E27		max Ø60	
<i>Polygregg media</i>	tavolo	LED retrofit / Fluo	E27	max 140	max Ø60	
<i>Gregg outdoor media</i>	tavolo/terra out./sosp. out.	LED retrofit / Fluo	E27	max 140	max Ø60	
<i>Rituals 1-2-3 G9</i>	tavolo	Halo / LED retrofit	G9			
<i>Rituals 1-2-3</i>	tavolo/sosp./soffitto/parete	LED retrofit dimmerabile / Fluo dimmerabile / Halo *	E27	max 110	max Ø70	
<i>Rituals XL</i>	tavolo/sospensione	LED retrofit dimmerabile / Fluo dimmerabile / Halo *	E27	max 140	max Ø60	
<i>Satellight</i>	sospensione	LED retrofit dimmerabile / Fluo dimmerabile / Halo *	E27	max 145	max Ø80	
<i>Solar</i>	outdoor	LED retrofit / Fluo	E27	max 135	max Ø150	
<i>Supernova</i>	sospensione	LED retrofit / Fluo	E27	white globe	max Ø120	
<i>Tartan</i>	sospensione	LED retrofit / Fluo / Halo	E27		max Ø120	
<i>Tite</i>	sospensione	LED retrofit / Fluo / Halo	E27		max Ø150	
<i>Tress stilo</i>	terra	Halo / LED retrofit dimm	E27-PAR	max 100	100	
<i>Tress grande</i>	sospensione	Halo / LED retrofit	R7s	118	max Ø150 (E27 PAR) max Ø23 (R7s)	
<i>Tress</i>	parete	Halo / LED retrofit	R7s	78	max Ø25	
<i>Tress media/piccola</i>	terra/sospensione	LED retrofit dimmerabile / Fluo dimmerabile / Halo *	E27/E27 PAR		max Ø150	
<i>Tress grande</i>	terra	Halo / LED retrofit	R7s/E27 PAR	118 (R7s)	max Ø150 (E27 PAR)	
<i>Tress mini</i>	sospensione	Halo / LED retrofit dimm	GU10-PAR		max Ø150	
<i>Troag 1-2-3</i>	sospensione	Fluo	G5	1449/1149/549	Ø16	
<i>Tutù</i>	parete	LED retrofit / Fluo / Halo	E14	max 85	max Ø40	
<i>Twiggy</i>	tav./ter./lettura/sosp./soffitto	LED retrofit dimmerabile / Fluo dimmerabile / Halo *	E27	max 130	max Ø75	
<i>Uto</i>	tavolo/sospensione/outdoor	LED retrofit / Fluo	E27	max 160	max Ø100	

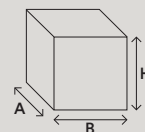

## Packing

Model	Version		N° boxes	Description	net weight kg	gross weight kg	size cm A x B x H	
<b>Allegretto</b>	<i>Assai</i>	sospensione	1	set rodes	8,7	13,0	91x61x29	
			1	frame	2,6	5,0	47x47x34	
	<i>Ritmico</i>	sospensione	1	set rodes	2,7	4,5	66x41x25	
			1	frame	2,4	4,7	47x47x34	
	<i>Vivace</i>	sospensione	1	set rodes	6,4	8,7	84x39x27	
			1	frame	2,7	5,1	47x47x34	
<b>Allegro</b>	<i>Assai</i>	sospensione	1	set rodes	31,0	46,5	187x37x27	
			1	frame	5,0	6,5	43x43x34	
	<i>Ritmico</i>	sospensione	1	set rodes	10,0	11,9	97x53x25	
			1	frame	5,0	6,5	43x43x34	
	<i>Vivace</i>	sospensione	1	set rodes	14,3	16,7	111x44x27	
			1	frame	5,0	6,3	43x43x34	
<b>Anisha</b>	<i>grande</i>	tavolo	1		0,7	1,7	51x37x10	
	<i>piccola</i>	tavolo	1		0,4	1,2	41x29x10	
<b>Aplomb</b>		sospensione	1		1,9	2,9	29x29x51	
	<i>large</i>	sospensione	1	canopy	1	1,1	24X24X9	
			1	frame	2,9	4,6	53X53X29	
	<i>mini</i>	sospensione	1		1,9	2,9	36x19x16	
		<i>outdoor</i>	sospensione	1		2,6	3,6	28x28x49
		parete	1		1,9	2,8	30x30x52	
<b>Arumi</b>		sospensione	1		1	1,5	23x23x20	
<b>Bahia</b>	<i>Fluo</i>	parete/soffitto	1		3,4	4,5	86x81x16	
	<i>LED</i>	parete	1		4,0	5,1	86x81x16	
	<i>mini</i>	parete/soffitto	1		2,0	4,3	62x62x18	
	<i>mini LED</i>	parete/soffitto	1		2,3	4,6	62x62x18	
<b>Behive</b>		sospensione	1	diffuser	2,3	4,7	49x49x41	
			1	frame	0,8	1,7	25x23x27	
		tavolo	1	diffuser	2,2	4,6	49x49x41	
			1	frame	1,5	2,2	21x21x34	
<b>Big Bang</b>		parete/soffitto	1	diffuser set	2,0	3,1	89x31x12	
			1	frame	1,0	1,4	23x23x9	
	<i>Halo</i>	sospensione	1	diffuser set	3,4	4,4	89x31x12	
			1	frame	2,0	3,3	89x31x12	
	<i>LED</i>	sospensione	1	diffuser set	3,4	4,4	89x31x12	
			1	frame	4,0	5,5	89x31x12	
<b>Big Bang L</b>		sospensione	1	diffuser set	13,0	15,0	134x41x9	
			1	frame	23,0	30,0	94x39x14	
			1	canopy	2,9	3,3	25x25x14	
<b>Big Bang XL</b>		sospensione	1	diffuser set	23,0	30,0	190x46x15	
			1	frame	12,0	15,0	131x58x50	
				canopy	2,9	3,3	25X25X14	
<b>Binic</b>		tavolo	1		0,6	1,3	22x22x14	
<b>Birdie</b>	<b>3</b>	soffitto	3	diffuser	0,4	0,8	23x23x26	
			1	canopy	1,0	2,0	24x24x14	
			1	set 3 arms	1,5	5,1	106x59x18	
	<b>6</b>	soffitto	6	diffuser	0,4	0,8	23x23x26	
			1	canopy	1,2	2,0	24x24x14	
			2	set 3 arms	1,5	5,1	106x59x18	
	<b>9</b>	soffitto	9	diffuser	0,4	0,8	23x23x26	
			1	canopy	1,4	2,0	24x24x14	
			3	set 3 arms	1,5	5,1	106x59x18	
	<b>6</b>	sospensione	6	diffuser	0,4	0,8	23x23x26	
			1	canopy	1,2	2,0	20x19x20	
			2	set 3 arms	1,5	5,1	106x59x18	
<b>9</b>			sospensione	9	diffuser	0,4	0,8	23x23x26
				1	canopy	1,4	2,0	20x19x20
				3	set 3 arms	1,5	5,1	106x59x18

Model	Version	N° boxes	Description	net weight kg	gross weight kg	size cm A x B x H	
<i>Birdie</i>	<i>grande</i>	tavolo	1 diffuser	0,7	1,5	30x30x35	
			1 frame	3,3	5,4	79x30x27	
	<i>piccola</i>	tavolo	1 diffuser	0,4	0,8	23x23x26	
			1 frame	1,6	3,0	26x26x53	
	<i>grande</i>	sospensione	1 diffuser	0,7	1,5	30x30x35	
			1 frame	0,7	1,7	20x20x29	
	<i>piccola</i>	sospensione	1 diffuser	0,4	0,8	23x23x26	
			1 frame	0,3	0,6	18x18x26	
		lettura	1 diffuser	0,7	1,5	30x30x35	
			1 frame	3,6	7,8	159x29x27	
		parete	1 diffuser	0,4	0,8	23x23x26	
			1 frame	1,2	2,5	50x20x29	
<i>Bit</i>	1	parete	1 glass	1,1	2,3	61x52x11	
			1 frame	0,6	1,0	19x19x14	
	2	parete	1 glass	0,4	2,3	51x37x11	
			1 frame	0,6	1,0	19x19x14	
	3	parete	1 glass	1,2	2,3	61x52x11	
			1 frame	0,6	1,0	19x19x14	
	4	parete	1 glass	0,6	2,3	51x37x11	
			1 frame	0,6	1,0	19x19x14	
	5	parete	1 glass	0,8	2,3	51x37x11	
			1 frame	0,6	1,0	19x19x14	
<i>Blob S</i>		parete/soffitto	1 diffuser	0,6	0,9	48x17x17	
			1 frame	0,5	0,8	48x13x9,5	
<i>Buds</i>	1	sospensione	1 glass	2,9	3,9	32x32x45	
			1 frame	0,7	0,9	19x19x14	
	2	sospensione	1 glass	4,2	7,2	51x51x34	
			1 frame	0,7	0,9	19x19x14	
	3	sospensione	1 glass	2,5	3,5	38x38x33	
			1 frame	0,7	0,9	19x19x14	
	1 LED	sospensione	1 glass	2,5	5,3	32x32x45	
			1 frame	1,3	2,0	28x23x20	
	2 LED	sospensione	1 glass	3,5	5,0	51x51x34	
			1 frame	1,3	2,0	28x23x20	
	3 LED	sospensione	1 glass	2,5	3,5	38x38x33	
			1 frame	1,3	2,0	28x23x20	
	1	tavolo	1 glass	2,9	3,9	32x32x45	
			1 frame	2,0	2,6	17x17x32	
	2	tavolo	1 glass	4,2	7,2	51x51x34	
			1 frame	2,0	2,6	17x17x32	
3	tavolo	1 glass	2,2	4,4	38x38x33		
		1 frame	2,0	2,6	17x17x35		
<i>Caboche</i>	<i>grande Halo</i>	sospensione	1 set sphere	12,1	13,5	51x51x15	
			1 frame	7,5	9,0	69x69x38	
	<i>grande LED</i>	sospensione	1 set sphere	12,1	13,5	51x51x15	
			1 frame	4,9	7,7	69x69x38	
	terra	sospensione	1 set sphere	12,1	13,5	51x51x15	
			1 frame	10,5	12,4	69x69x52	
			1 set stem	1,3	2,0	155x11x12	
	<i>media Halo</i>	sospensione	1 set sphere	6,4	7,2	38x38x14	
			1 frame	3,8	4,9	52x52x28	
	<i>media LED</i>	sospensione	1 set sphere	6,4	7,2	38x38x14	
			1 frame	3,8	5,1	52x52x28	
	<i>media</i>	parete	sospensione	1 set sphere	2,7	3,5	31x26x15
				1 frame	1,8	2,6	45x17x38
		terra	sospensione	1 set sphere	6,4	7,2	38x38x14
				1 frame	4,4	6,5	51x51x36
			1 set stem	1,0	1,7	155x11x12	
		<i>piccola</i>	parete	sospensione	1 set sphere	1,5	2,2
				1 frame	1,1	2,0	18x29x32
	sospensione		sospensione	1 set sphere	3,2	3,8	47x24x11
				1 frame	1,6	2,0	29x29x38
tavolo	sospensione		1 set sphere	3,2	3,8	47x24x11	
			1 frame	2,1	2,5	29x29x51	

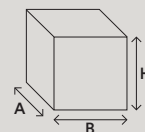
**Packing**

Model	Version	N° boxes	Description	net weight kg	gross weight kg	size cm A x B x H	
<b>Caboche</b>	<i>soffitto</i>	1	set sphere	5,2	6,4	38x35x15	
		1	frame	3,9	4,8	52x52x28	
<b>Caiigo</b>	sospensione	1		2,0	3,0	28x28x36	
<b>Chouchin &amp; reverse</b>	1	sospensione	1	glass	3,7	5,4	51x51x44
		1	frame	0,7	0,8	19x19x14	
	2	sospensione	1	glass	2,2	3,6	34x34x55
		1	frame	0,7	1,0	19x19x14	
	3	sospensione	1	glass	2,9	3,6	38x38x33
		1	frame	0,7	0,8	19x19x14	
	1 LED	sospensione	1	glass	3,7	5,4	51x51x44
	2 LED	sospensione	1	frame	1,3	2,0	28x23x20
		1	glass	2,2	3,6	34x34x55	
	3 LED	sospensione	1	frame	1,3	2,0	28x23x20
1		glass	2,9	3,6	38x38x33		
<b>Chouchin mini</b>	1	sospensione	1	frame	1,3	2,0	28x23x20
		sospensione	1	glass	1,0	1,6	28x22x19
<b>Circus</b>	grande	parete/soffitto	1	glass	3,0	4,4	51x51x15
		1	frame	1,7	2,7	42x42x17	
	piccola	parete/soffitto	1	glass	1,6	2,0	42x42x17
		1	frame	0,5	0,7	19x19x14	
<b>Cri Cri</b>	terra/ tavolo	1		1,0	1,2	21x22x7	
<b>Dolmen</b>	terra	1		11	15,3	52x15x215	
	sospensione	1		11	15,3	52x15x215	
<b>Double</b>	parete	1	diffuser	1,5	1,9	36x36x23	
		1	frame	0,5	0,7	25x15x10	
<b>Fields</b>	1	parete	1		6,0	8,0	177x22x14
		1	diffuser set	1,3	1,5	76x25x4	
	2	1	frame	5,2	7,5	134x25x31	
		1	diffuser set	1,3	1,6	60x32x3	
3	1	frame	4,5	6,1	104x25x25		
	1		4,2	4,8	67x30x18		
<b>Filo</b>	tavolo	1		4,2	4,8	67x30x18	
	lettura	1		5,7	8,8	159x34x20	
	parete	1		2,2	3,9	88x32x19	
<b>Folio</b>	grande	parete	1	glass	1,6	3,0	62x52x18
		1	frame	0,6	0,9	56x13x10	
		1	glass	1,6	3,0	62x52x18	
	piccola	1	frame	0,6	1,1	57x27x11	
		parete	1	glass	1,0	1,3	38x35x15
		1	frame	0,5	0,8	37x13x10	
<b>Gem</b>	sospensione	1	glass	5,4	7,8	52x52x50	
		1	frame	0,7	0,8	19x19x14	
	LED	sospensione	1	glass	5,4	7,8	52x52x50
		1	frame	1,3	2,0	28x23x20	
<b>Giga-Lite</b>	sospensione	1	diffuser	1,5	2,7	57x57x46	
		1	frame	1,0	1,6	29x27x23	
	terra	1	diffuser	1,5	2,7	57x57x46	
		1	frame	8,3	10,9	144x30x14	
<b>Gregg</b>	grande	sospensione	1	glass	5,0	7,0	56x48x47
		1	frame	0,6	0,7	19x19x14	
	grande LED	sospensione	1	glass	5,0	7,0	56x48x47
		1	frame	1,3	2,0	28x23x20	
	tavolo	1	glass	5,0	7,0	56x48x47	
		1	frame	1,8	2,5	23x23x19	
		grande alta	terra	1	glass	5,0	7,0
1	base	7,2	8,3	55x55x3			
1	frame	2,5	5,0	166x20x20			

Model	Version	N° boxes	Description	net weight kg	gross weight kg	size cm A x B x H
<b>Gregg</b>	<i>media alta</i>	terra	1 glass	2,5	2,8	38x33x30
			1 base	7,2	8,3	55x55x3
			1 frame	2,5	5,0	166x20x20
	<i>media</i>	parete/soffitto	1 glass	2,5	2,8	38x33x30
			1 frame	0,4	0,7	19x19x18
		sospensione	1 glass	2,5	2,8	38x33x30
			1 frame	0,6	0,7	19x19x14
	<i>media LED</i>	sospensione	1 glass	2,5	2,8	38x33x30
			1 frame	1,3	2,0	28x23x20
		tavolo	1 glass	2,5	2,8	38x33x30
			1 frame	0,8	1,2	19x19x18
	<i>MIDI</i>	tavolo	1	1,4	1,9	26x25x27
			sospensione	1	1,35	1,85
		parete/soffitto	1	1,4	1,9	26x25x27
	<i>piccola</i>	parete/soffitto	1	0,6	0,9	27x19x20
sospensione			1	0,7	0,9	27x19x20
tavolo		1	0,6	0,9	27x19x20	
<b>Gregg outdoor</b>	<i>grande</i>	sospensione	1 diffuser	2,3	3,5	50x42x39
			1 frame	0,7	1,5	20x17x26
		terra	1 diffuser	2,3	3,5	50x42x39
			1 frame	1,3	2,3	28x28x15
	<i>media</i>	sospensione	1 diffuser	0,7	1,4	33x28x26
			1 frame	0,7	1,5	20x17x26
		terra	1 diffuser	0,7	1,4	33x28x26
			1 frame	0,9	1,7	21x21x15
	<i>XL</i>	sospensione	1 diffuser	3,0	5,4	63x53x50
			1 frame	0,7	1,2	20x17x26
		terra	1 diffuser	3,0	5,4	63x53x50
			1 frame	1,3	2,3	28x28x15
	<b>Havana outdoor</b>	sospensione	1 diffuser	2,0	3,3	25x25x132
			1 frame	1,0	1,4	64x13x10
		<i>base</i>	terra	1 diffuser	2,0	3,3
1 base				6,1	6,5	37x37x3
			1 frame	2,0	2,9	107x14x14
<i>cilindro</i>		terra	1 diffuser	2,0	3,3	25x25x132
			1 underground base	0,5	0,7	15x14x24
			1 frame	3,0	4,0	107x14x14
<i>picchetto</i>		terra	1 diffuser	2,0	3,3	25x25x132
			1 stake mounted	1,2	1,5	14x13x46
			1 frame	2,0	2,5	107x14x14
<i>bassa base</i>		terra	1 diffuser	2,0	3,3	25x25x132
			1 base	6,1	6,5	37x37x3
			1 frame	2,0	2,9	107x14x14
<i>bassa cilindro</i>		terra	1 diffuser	2,0	3,3	25x25x132
	1 underground base		0,5	0,7	15x14x24	
		1 frame	3,0	3,8	107x14x14	
<i>bassa picchetto</i>	terra	1 diffuser	2,0	3,3	25x25x132	
		1 stake mounted	1,2	1,5	14x13x46	
		1 frame	1,5	2,4	107x14x14	
<b>Havana</b>	sospensione/parete	1 diffuser set	1,3	1,8	49x25x25	
		1 frame	0,6	0,8	19x19x14	
	terra	1 diffuser set	1,3	1,8	49x25x25	
		1 frame	2,0	3,0	100x29x15	
<b>Innerlight</b>	parete	1 diffuser set	3,3	4,3	79x20x26	
		1 frame	1,7	3,0	69x30x16	
<b>Kite</b>	parete	1 diffuser	0,3	1,3	52x37x27	
		1 frame	0,2	0,6	26x16x11	
<b>Kurage</b>	tavolo	1	0,7	3,5	39x39x65	
<b>Lake</b>	parete	1 diffuser	1,3	2,5	58x50x12	
		1 frame	0,4	0,7	18x18x17	
<b>Le Soleil</b>	parete	1 diffuser set	0,8	1,5	38x31x12	
		1 frame	0,8	1,3	28x22x11	
	sospensione	1 diffuser set	4,1	6,0	61x61x23	
		1 frame	1,2	2,2	25x25x33	
<b>Lightweight</b>	sospensione	1	7,6	21,6	113x112x82	

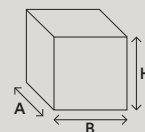
**Packing**

Model	Version		N° boxes	Description	net weight kg	gross weight kg	size cm A x B x H
<b>Lumiere</b>	<i>grande</i>	tavolo	1	glass	1,5	2,1	33x33x26
			1	frame	0,9	1,4	49x25x25
	<i>piccola</i>	tavolo	1	glass	0,6	1,2	26x26x21
			1	frame	0,5	0,8	21x40x19
			1	glass	1,8	2,1	41x41x20
			1	frame	1,6	3,0	42x42x17
<b>Lumiere XXL</b>	parete/soffitto		1	glass	1,8	2,1	41x41x20
			1	frame	1,6	3,0	42x42x17
	tavolo	1	glass	4,0	5,3	50x50x37	
		1	frame	1,5	2,8	38x38x61	
	lettura		1	glass	2,8	5,0	130x24x5
			1	frame	1,3	1,8	41x24x7
		parete/soffitto	1	glass	1,0	1,6	31x31x17
			1	frame	0,8	1,7	30x30x10
<b>Lumiere XXS</b>	tavolo		1	glass	1,2	2,3	33x33x26
			1	frame	0,6	1,7	43x27x27
<b>Maki</b>		sospensione	1		0,5	0,8	31x17x15
<b>Mite</b>		terra	1		7,0	11,1	28x28x197
<b>Nuage</b>	parete/soffitto		1	diffuser set	1,4	3,6	71x71x16
			1	frame	1,8	3,0	41x41x13
<b>Orbital</b>		terra	1	glass set	4,1	5,5	71x52x13
			1	frame	6,0	9,7	185x32x27
<b>O-Space</b>		sospensione	1		4,4	6,0	67x55x42
<b>Plass</b>	<i>grande</i>	sospensione	1	diffuser	18,0	24,0	119x79x79
			1	frame	5,0	10,0	129x31x31
<b>Plass</b>	<i>media</i>	sospensione	1	diffuser	2,8	3,5	36x36x52
			1	frame	0,7	1,2	47x22x14
		tavolo	1	diffuser	2,8	3,5	36x36x52
			1	frame	1,2	2,0	22x22x32
<b>Polygregg</b>	<i>grande</i>	tavolo	1	diffuser	2,3	3,5	50x42x39
			1	frame	1,3	1,9	28x28x15
	<i>media</i>	tavolo	1	diffuser	0,7	1,4	33x28x26
			1	frame	0,9	1,4	21x21x15
	<i>XL</i>	tavolo	1	diffuser	3,0	5,4	63x53x50
			1	frame	1,3	1,9	28x28x15
<b>Rituals</b>	<b>1</b>	parete	1	glass	3,4	4,0	33x33x40
			1	frame	1,4	2,0	28x19x18
		soffitto	1	glass	3,4	4,0	33x33x40
			1	frame	0,7	1,1	19X19X21
		sospensione	1	glass	3,4	4,0	33x33x40
			1	frame	0,5	0,8	19x19x14
	tavolo	1	glass	3,4	4,0	33x33x40	
		1	frame	0,6	1,2	26x25x18	
	<b>2</b>	soffitto	1	glass	3,5	4,0	41x41x26
			1	frame	0,7	1,1	19x19x21
		sospensione	1	glass	3,5	4,0	41x41x26
			1	frame	0,5	0,8	19x19x14
		tavolo	1	glass	3,5	4,0	41x41x26
			1	frame	0,6	1,2	26x25x18
	<b>3</b>	parete	1	glass	1,0	1,6	25x25x26
			1	frame	1,4	2,0	28x19x18
		soffitto	1	glass	1,0	1,6	25x25x26
			1	frame	0,7	1,1	19x19x21
sospensione		1	glass	1,0	1,6	25x25x26	
		1	frame	0,5	0,8	19x19x14	
tavolo	1	glass	1,0	1,6	25x25x26		
	1	frame	0,6	1,2	26x25x18		

Model		Version	N° boxes	Description	net weight kg	gross weight kg	size cm A x B x H
<i>Rituals</i>	<i>XL</i>	tavolo	1	diffuser	5,4	8,4	51x54x50
			1	frame	1,2	2,0	22x22x32
		sospensione	1	diffuser	5,4	8,4	51x54x50
			1	frame	0,6	0,7	19x19x14
	<i>XL LED</i>		1	diffuser	5,4	8,4	51x54x50
		1	frame	1,3	2,0	28x23x20	
<i>Satellight</i>		tavolo	1		3,0	3,7	31x31x52
		sospensione	1		5,5	6,3	44x44x54
		parete	1		1,4	2,2	30x30x38
<i>Solar outdoor</i>		terra	1	diffuser	9,4	13,7	87x87x27
			1	frame	2,3	3,6	31x31x17
<i>Spokes</i>	<i>1</i>	sospensione	1	canopy	1,0	1,1	24x24x9
			1	structure	4,5	6,0	41x41x80
	<i>2</i>	sospensione	1	canopy	1,0	1,1	24x24x9
			1	structure	5,0	6,5	60x60x61
	<i>2 large</i>	sospensione	1	canopy	1,0	1,1	24x24x9
		1	structure	6,0	7,5	80x80x83	
<i>Supernova</i>		sospensione	1		8,0	10,6	82x72x17
<i>Tartan</i>		sospensione	1	diffuser	4,0	6,5	49x49x44
			1	frame	0,7	0,8	19x19x14
<i>Tartan</i>	<i>LED</i>	sospensione	1	diffuser	4,0	6,5	49x49x44
			1	frame	1,3	2,0	28x23x20
<i>Tite</i>	<i>1</i>	sospensione	1	diffuser	0,8	2,0	123x29x30
			1	frame	0,6	1,2	80x16x14
			1	diffuser	0,5	1,3	64x27x27
	<i>2</i>	sospensione	1	frame	0,5	1,1	45x16x14
<i>Tress</i>	<i>grande</i>	parete	1	diffuser	0,4	1,6	68x32x19
			1	frame	0,7	0,9	36x12x9
			1	diffuser	1,1	2,9	51x51x44
		sospensione	1	frame	3,8	3,7	46x46x23
	<i>grande LED</i>		1	diffuser	1,1	2,9	51x51x44
			1	frame	2,0	3,3	89x31x12
		terra	1	frame+diffuser	5,0	8,5	200x30x34
	1		base	5,5	6,0	26x26x3	
	<i>grande Halo</i>	terra	1	frame+diffuser	3,0	7,0	200x30x34
			1	base	5,5	6,0	26x26x3
	<i>media</i>	sospensione	1	diffuser	1,6	3,5	118x30x30
			1	frame	0,8	1,0	21x21x15
		terra	1	diffuser	1,6	3,5	118x30x30
	1		frame	2,3	2,5	28x28x15	
	<i>piccola</i>	parete	1	diffuser	0,3	1,5	48x32x19
1			frame	0,8	1,0	36x12x9	
1			diffuser	0,9	1,8	61x61x23	
	sospensione	1	frame	0,8	1,0	21x21x15	
<i>mini</i>		1	diffuser	0,4	1,4	52x26x26	
		1	frame	0,7	0,8	19x19x14	
<i>Tress Stilo</i>		sospensione	1		0,5	1,2	76x12x12
		terra	1	frame+diffuser	1,6	4,5	205x21x21
			1	base	2,6	2,9	30x30x4
<i>Troag</i>	<i>grande</i>	sospensione	1		3,5	6,0	227x16x15
	<i>media</i>	sospensione	1		2,8	5,2	197x16x15
	<i>piccola</i>	sospensione	1		1,8	3,9	137x16x15
<i>Tuareg</i>	terra		1	structure	2,8	4,2	87x87x106
			1	base	6,4	8,8	157x24x17
<i>Tutù</i>		parete	1	glass	0,5	1,2	37x18x24
			1	frame	0,3	0,7	36x12x9
<i>Twice as Twiggy</i>		sospensione	1	diffuser	5,4	8,4	85x85x56
			1	canopy	2,9	3,3	25x25x14
	terra	1	diffuser	5,4	12,7	87x87x58	
		1	stem	5,0	8,1	203x26x16	
		1	base	7,0	13,7	113x112x4	
		1	ballast	29,5	37,5	85x80x7	
		1	ballast base	24,4	29,0	109x109x10	
	1	assembling tool	3,0	4,4	38x18x103		

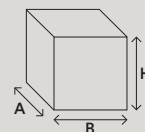
**Packing**

Model	Version	N° boxes	Description	net weight kg	gross weight kg	size cm A x B x H
<b>Twiggy</b>	sospensione	1	diffuser	1,6	2,8	51x51x32
		1	frame	0,8	1,1	56x16x17
	lettura	1	diffuser	1,0	2,1	51x51x32
		1	frame	1,5	3,0	164x21x22
		1	base	8,3	8,7	55x55x6
	soffitto	1	diffuser	1,6	2,8	51x51x32
		1	frame	4,0	6,0	194x30x18
	terra	1	diffuser	1,6	2,8	51x51x32
		1	frame	1,5	3,9	187x21x23
		1	base	13,5	15,3	69x69x7
<b>LED</b>	terra	1	stem set	0,1	0,4	96x6x7
		1	diffuser	1,6	3,5	51x51x32
		1	frame	2,0	3,0	171x19x12
		1	base	13,5	15,3	69x69x7
<b>Twiggy XL</b>	tavolo	1	diffuser	1,1	1,5	69x22x23
		1	frame	1,1	1,5	68x21x22
		1	base	4,7	5,5	45x45x6
<b>Twiggy Grid</b>	sospensione	1	diffuser	1,6	2,8	51x51x32
		1	frame	1,2	2,0	40x38x18
	terra	1	diffuser	1,6	2,8	51x51x32
		1	frame	2,1	5,9	193x37x13
	1	base	13,5	15,3	69x69x7	
<b>Uto</b>		1		2,0	3,4	80x30x22
<b>Accessories</b>						
<b>Rosone multiplo</b>	tondo	1		9,0	10,7	61x61x9
	lineare 90	1		6,8	7,7	100x27x9
	lineare 135	1		10,0	11,5	145x27x9
<b>Kit cable reels outdoor</b>		1		0,2	0,4	52x5x5





Foscarini SpA

via delle Industrie 27  
30020 Marcon / Venezia / Italy  
T +39 041 595 3811  
F +39 041 595 3820  
foscarini@foscarini.com

Foscarini Inc

20 Greene Street, New York  
NY /10013 / USA  
T +1 212 247 2218  
F +1 646 545 2564  
foscarini.inc@foscarini.com

Foscarini Japan K.K.

Oak Minami-Azabu Building,  
19-23 Minami-Azabu  
3-chome,  
Minato-ku Tokyo / Japan  
106-0047  
foscarini.jp@foscarini.com

Foscarini Spazio Monforte

Corso Monforte 19  
20122 / Milano / Italy  
T +39 02 870 71320  
spaziomonforte@foscarini.com

Foscarini Spazio Soho

20 Greene Street, New York  
NY /10013 / USA  
T +1 212 257 4412  
spaziosoho@foscarini.com

Azienda certificata

UNI EN ISO 9001:2015

UNI EN ISO 14001:2015

edition 11.2018

Concept and graphic design:  
Designwork  
art direction: Artemio Croatto  
art work: Erika Pittis / Designwork

Photography:

Andrea Ferrari  
Massimo Gardone /Azimut  
Kasia Gatkowska  
Tommaso Sartori

Printed in Italy

Grafiche GFP

[foscarini.com](http://foscarini.com)

Follow us:



@foscarinilamps





**FOSCARINI**